



**Solstice Electric Fryers  
SE Series  
Service Manual**

## Notice

---

In the event of problems or questions about your order, contact the Pitco Frialator factory at (603) 225-6684.

In the event of problems or questions about your equipment, contact the Pitco Frialator Authorized Service and Parts representative (ASAP) covering your area, or contact Pitco at the numbers listed above.

### MAILING ADDRESS

Pitco Frialator  
P.O. Box 501  
Concord, NH 03302-0501

### SHIPPING ADDRESS

Pitco Frialator  
10 Ferry Street  
Concord, NH 03301

EQUIPMENT REFERENECE INFORMATION
Model #: _____
Serial #: _____
Date Purchased: _____

# Table of Contents

---

<b>Serial Numbers .....</b>	<b>5</b>
<b>Theory of Operation .....</b>	<b>7</b>
<b>Fryer Components Operation.....</b>	<b>8</b>
Heating System .....	8
Hi-Limit System.....	8
Filter System .....	9
<b>SE Model.....</b>	<b>10</b>
<b>Accessing Fryer for Servicing.....</b>	<b>11</b>
Powering Down the Unit .....	11
Removing the Controller Front Panel Bezel.....	12
Removing the Entrance Box Covers.....	13
Removing the Entrance Box Wire Guard.....	14
Removing the Relay Board.....	15
Removing Solid State Thermostat (If Necessary) .....	16
<b>Checking Resistance .....</b>	<b>17</b>
Checking the Resistance of the Transformer .....	17
Diagram Identifying Terminals for Second Resistance .....	18
Checking the Resistance of the DVI Switch.....	18
Checking the Resistance of the Safety Contactor.....	19
Checking the Resistance of the HD Contactor .....	20
Checking the Resistance of the Hi-Limit.....	21
Checking the Resistance of the Probe.....	22
<b>Replacing the Relay Board and Paper .....</b>	<b>23</b>
<b>Replacing the Transformer.....</b>	<b>23</b>
<b>Replacing the DVI Switch .....</b>	<b>25</b>
<b>Replacing the Safety Contactor .....</b>	<b>26</b>
<b>Replacing the HD Contactor.....</b>	<b>27</b>
<b>Replacing the Probe.....</b>	<b>28</b>
<b>Replacing the Hi-Limit.....</b>	<b>30</b>
<b>Replacing the Element.....</b>	<b>31</b>
<b>Replacing the Tank.....</b>	<b>33</b>
<b>Filter System .....</b>	<b>38</b>
<b>Replacing the Flush Hose Assembly and Valve .....</b>	<b>39</b>
<b>Replacing the Filter Pump and Motor .....</b>	<b>42</b>
Removing the Filter Pump and Motor .....	42
Replacing Seal Kit .....	44
Removing the Filter Pump from the Motor .....	45
<b>Replacing the Pump Relay and Circuit Breaker .....</b>	<b>46</b>

Replacing the Circuit Breaker.....	46
Replacing the Pump Relay.....	47
<b>Troubleshooting and Problem Isolation .....</b>	<b>48</b>
<b>Troubleshooting and Problem Isolation .....</b>	<b>49</b>
Interpretation of Solid State Controller Lights .....	49
Solid State Thermostat Field Calibration.....	50
<b>Component Troubleshooting .....</b>	<b>51</b>
Probe .....	51
HD Contactor .....	51
Safety Contactor.....	51
Hi-Limit .....	51
Drain Valve and Return Valve Switches .....	52
Transformer.....	52
Elements.....	52
Relay Board .....	52
Computer Control .....	53
Backup Solid State Control.....	53
Probe Resistance Chart.....	55
<b>Wiring Diagrams .....</b>	<b>56</b>
<b>Simplified Wiring Diagrams .....</b>	<b>57</b>
<b>US and Canada Wiring Diagrams (Controls) .....</b>	<b>58</b>
<b>US and Canada Wiring Diagrams (Replacement Parts List) .....</b>	<b>59</b>
<b>US and Canada Wiring Diagrams (Basket Lift Option) .....</b>	<b>60</b>
<b>US and Canada Wiring Diagrams (Filter Pump Option) .....</b>	<b>61</b>
<b>US and Canada Wiring Diagrams (Single Phase Twin Vat) .....</b>	<b>62</b>
<b>US and Canada Wiring Diagrams (Single Phase Full Vat) .....</b>	<b>63</b>
<b>US and Canada Wiring Diagrams (3 Phase Full Vat) .....</b>	<b>64</b>
<b>Export and CE Wiring Diagrams (Filter Pump Option) .....</b>	<b>65</b>
<b>Export and CE Wiring Diagrams (Single Phase Twin Vat) .....</b>	<b>66</b>
<b>Export and CE Wiring Diagrams (Single Phase Full Vat) .....</b>	<b>67</b>
<b>Export and CE Wiring Diagrams (3 Phase Full Vat).....</b>	<b>68</b>
<b>Export and CE Wiring Diagrams (3 Phase Twin WYE Vat) .....</b>	<b>69</b>
<b>Export and CE Wiring Diagrams (3 Phase Twin Delta Vat).....</b>	<b>70</b>
<b>Notes.....</b>	<b>71</b>

# Serial Numbers



### Serial Numbers

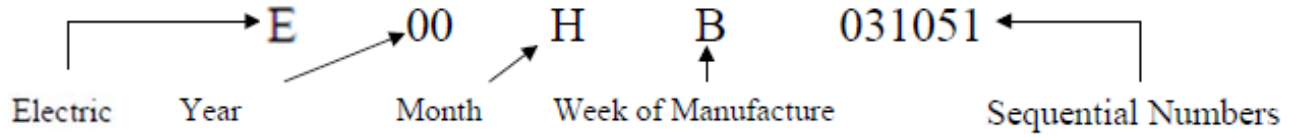

G = Gas      All Models of Gas Fryers & Broilers

E = Electric      All Models of Electric Fryers

F = Filters      All Filters

#### Months

A=January

B = February

C = March

D = April

E=May

F= June

G=July

H= August

J=September

K=October

L=November

M=December

# Theory of Operation

## Fryer Components Operation

---

The SE fryer components function in specific order of operation. Knowing and understanding the sequence of fryer and components operation enables you to diagnose equipment failure more accurately.

### Heating System

---

The unit is connected to line voltage:

- If Fuse F1 on the relay board is good:
  - The A.C. indicator is illuminated.
  - The controller is supplied with 24 VAC.
  - With the drain valve handle closed, the proximity switch supplies 24 VAC to the drain valve interlock (DVI) input at the controller.
  - 24 VAC is at the Side On (SO) relay COM contact.
- The controller is turned ON:
  - The SO indicator on the relay board is illuminated.
  - The SO relay is energized, closing the circuit.
  - The safety (SO) contactor energizes if the hi-limit is not tripped.
  - With the roll out switch and hi-limit in the closed position, the ignition module receives 24VAC at terminal 6 (24 VAC).

### Hi-Limit System

---

If the hi-limit trips:

- The SO and HD contactors lose 24 VAC supply and the HFB loses 24 VAC.
- The computer displays “HEATING”.
- The HD lamp is illuminated on the Back-up T-stat and the HFB lamp is not illuminated.
- After the hi-limit resets (unit cools to 375°F ±20°F (191°C ±20°C)), turn the controller off and then back on for the unit to heat.



## Filter System

---

- Opening the RED return valve handle, does the following:
  - Opens the return valve to that vat.
  - Closes the pump proximity switch causing the “pump run” relay to be energized.
  - Starts the pump motor.
- Closing the return valve handle de-energizes the relay and the pump motor stops running and the return valve closes.
- The pump system is equipped with a circuit breaker which de-energizes the system and the heat tape in the event of over current. The circuit breaker must be in the “ON” position for the pump and heat tape to operate.

**NOTE: Circuit Breaker should remain in the “ON” position at all times.**

- The return piping system may be provided with optional heat tape to prevent solidification of solid shortening. The heat tape is low wattage and is on constantly to maintain liquid shortening in the line.

# SE Model

## Accessing Fryer for Servicing

---

### Powering Down the Unit

---

1. Press the OFF button  on control panel.



3. Unplug all power cord and disconnect power.



2. Slide button to solid state.



## Removing the Controller Front Panel Bezel

---

1. Remove the two (2) screws on the controller panel using a Phillips screwdriver.



2. Pull out the controller panel front bezel.



3. Disconnect the controller wiring harness.

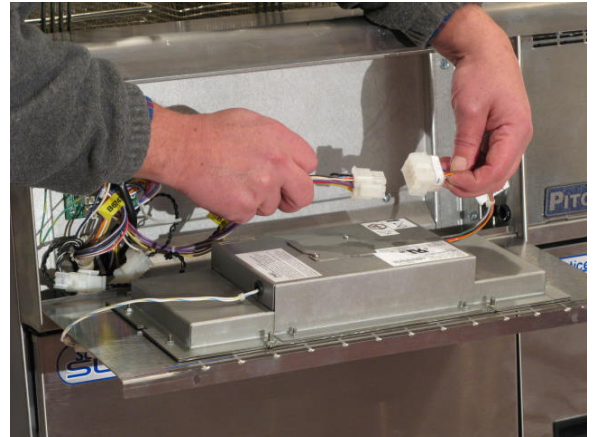

4. Remove the controller panel front bezel from the unit.
5. Follow steps 1 through 4 in reverse to reattach the front panel bezel.

## Removing the Entrance Box Covers

1. Remove the two (2) screws on the entrance box lower cover located on the left side of the unit using a Philips screwdriver.



2. Remove the four (4) screws entrance box lower cover located on the right side of the unit using a Philips screwdriver.



3. Remove the two (2) screws on the entrance box upper cover using a Philips screwdriver.

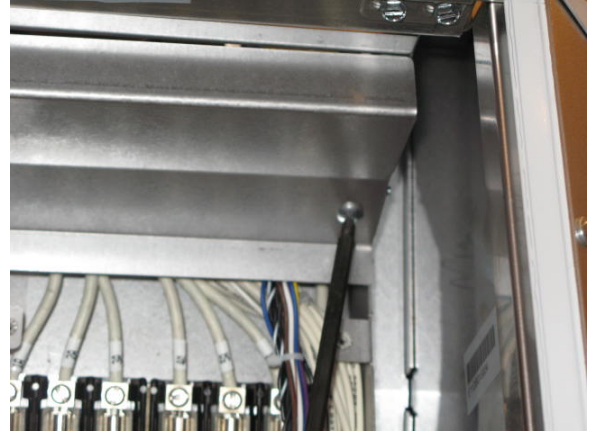

4. Follow steps 1 through 3 in reverse to reinstall the entrance box covers.

## Removing the Entrance Box Wire Guard

---

1. Remove the two (2) screws on the wire guard using a 5/16 inch hex wrench.



3. Follow steps 1 through 2 in reverse to reinstall the entrance wire guard.

2. Slide the wire guard down to remove.

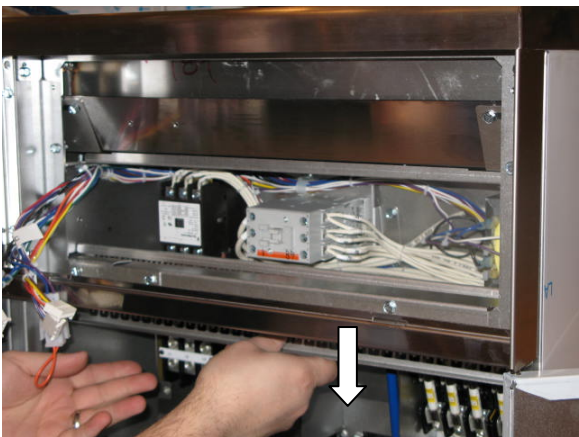

## Removing the Relay Board

---

1. Remove the front panel. See “Removing the Controller Front Panel Bezel” on page 12.
2. Disconnect all the connections (J41, J35, J32, and J34) from the relay board.
3. Remove the four (4) screws, which hold down the relay board bracket, using a 5/16 inch socket.
4. Remove the relay board.
5. Follow steps 1 through 4 in reverse to reinstall the relay board.

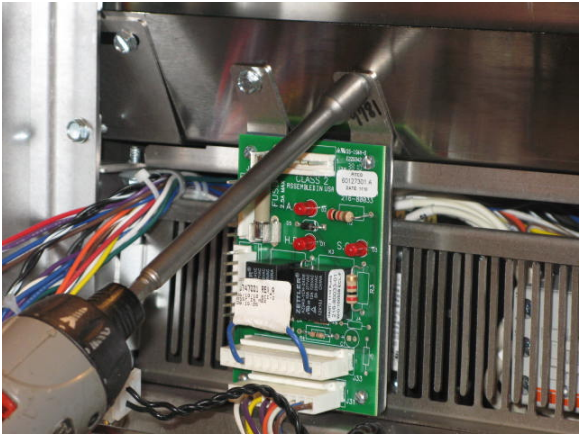

## Removing Solid State Thermostat (If Necessary)

---

1. Remove the two (2) screws, which hold the solid state thermostat, using a 5/16 inch socket.

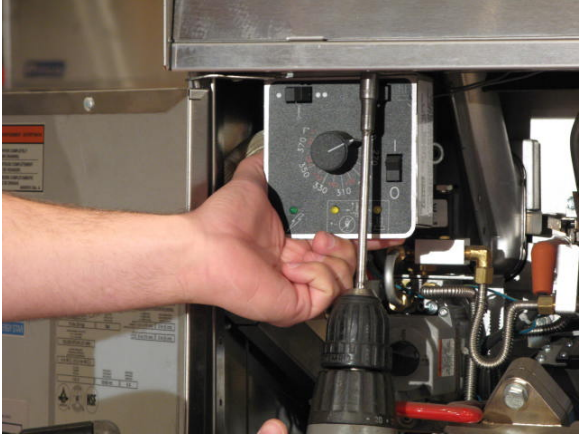

2. Disconnect solid state thermostat control harness.

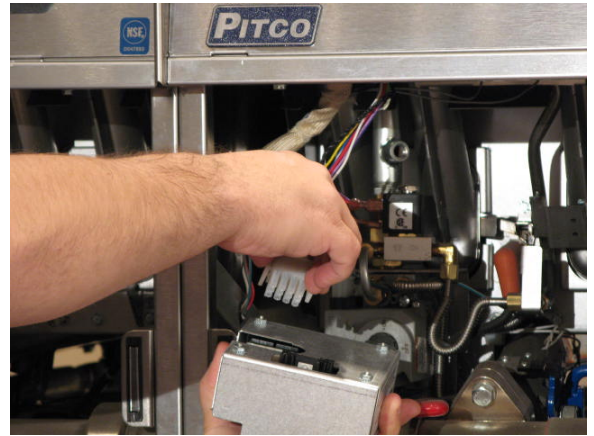
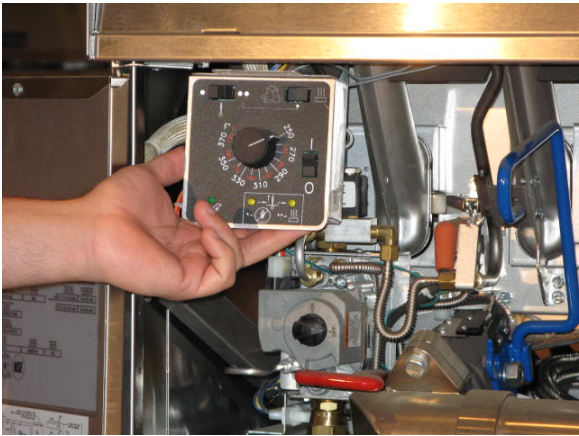
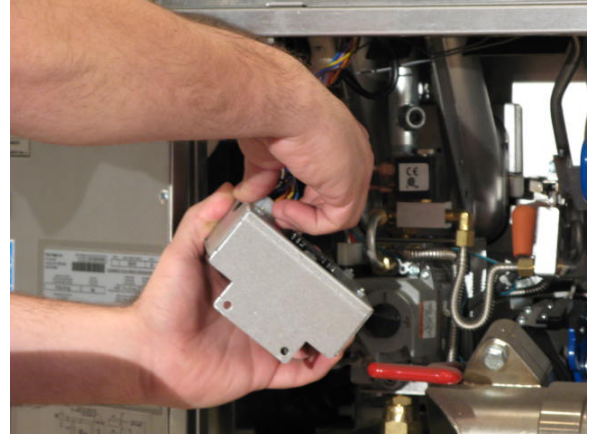



## Checking Resistance

### Checking the Resistance of the Transformer

1. Disconnect all electrical power. Remove the front panel (see “Removing the Controller Front Panel Bezel” on page 12), entrance box covers (see “Removing the Entrance Box Covers” on page 13), and entrance box wire guard (see “Removing the Entrance Box Wire Guard” on page 14).
2. Disconnect the secondary side terminals.

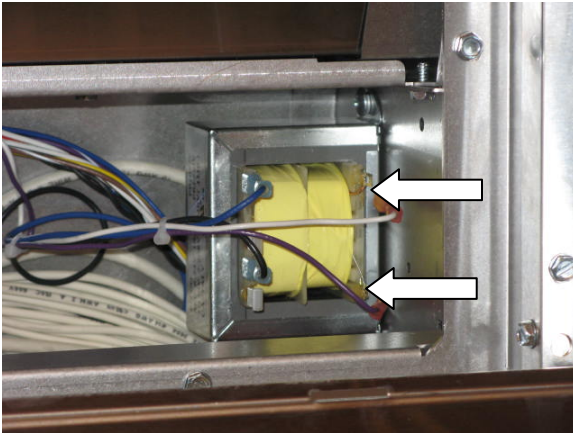

3. Connect the multimeter to the secondary terminals and check the resistance.



#### Secondary Terminals

.7 ohms = +/- 20ohms

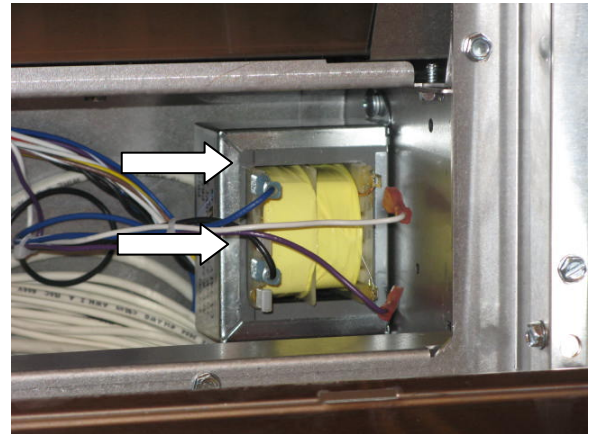

4. Disconnect the primary side terminals.



5. Connect the black lead of multimeter to the primary terminal marked “5” and check the resistance readings of taps in following chart on page 18.

## Diagram Identifying Terminals for Second Resistance

PP10429			PP10428		
Secondary Resistance			Secondary Resistance		
TAP	Volts	Resistance	TAP	Volts	Resistance
10 - 6	24V	0.7	10 - 6	24V	0.6
Primary Resistance			Primary Resistance		
Tap	Volts	Resistance	Tap	Volts	Resistance
5 - 1	240V	30.4	5 - 1	480V	119.5
5 - 2	208V	25.3	5 - 2	440V	107.7
5 - 3	120V	9.9	5 - 3	380V	90.2

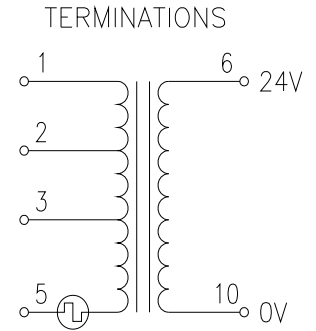

## Checking the Resistance of the DVI Switch

1. Remove the DVI connection.

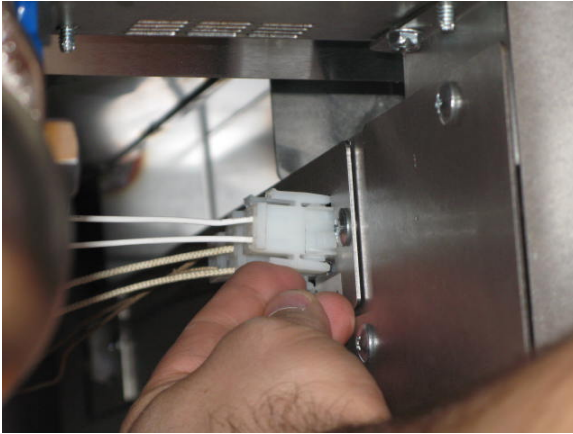

2. Connect the multimeter to the DVI leads and check the resistance.



**DVI Resistance Table**

Valve Closed	Valve Open
Near Zero Ohm	Open Circuit

## Checking the Resistance of the Safety Contactor

1. Remove the front panel (see “Removing the Controller Front Panel Bezel” on page 12), entrance box covers (see “Removing the Entrance Box Covers” on page 13), and entrance box wire guard (see “Removing the Entrance Box Wire Guard” on page 14).
2. Disconnect the coil connections.
3. Connect the multimeter to the coil connections and check the resistance.

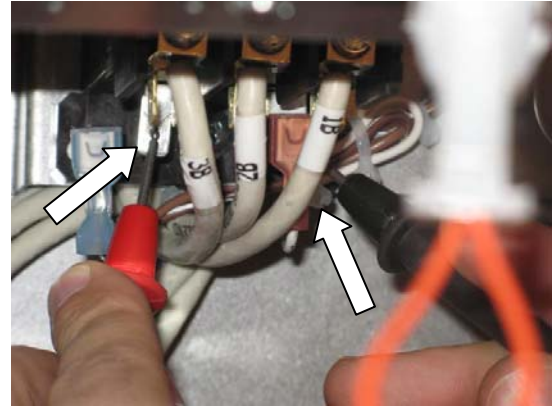
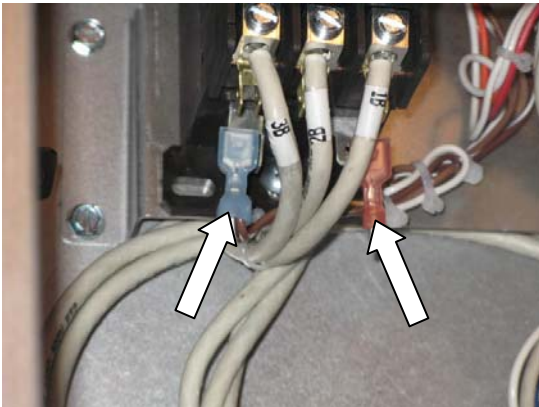
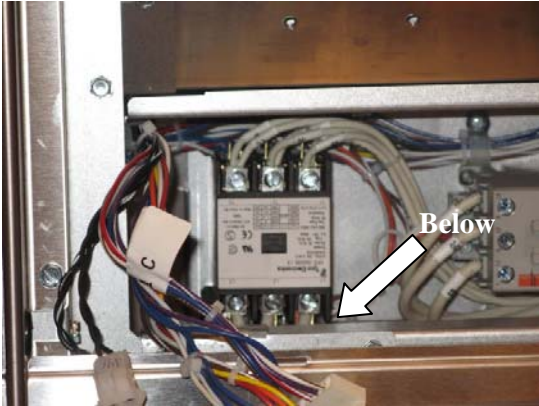

## Checking the Resistance of the HD Contactor

---

1. Remove the front panel (see “Removing the Controller Front Panel Bezel” on page 12), entrance box covers (see “Removing the Entrance Box Covers” on page 13), and entrance box wire guard (see “Removing the Entrance Box Wire Guard” on page 14).
2. Remove the two (2) screws from the coil using a Philips screwdriver.



3. Connect the multimeter to the connections and check the resistance.

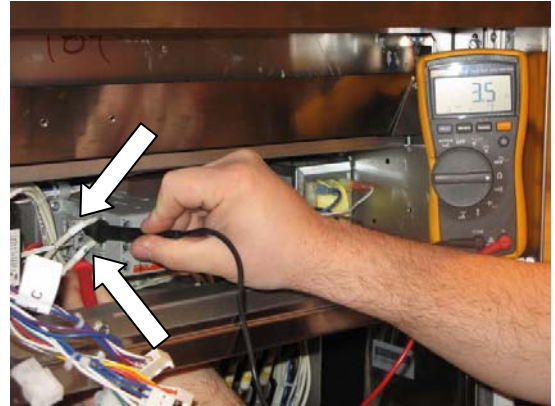

## Checking the Resistance of the Hi-Limit

---

1. Remove the Hi-Limit connection.

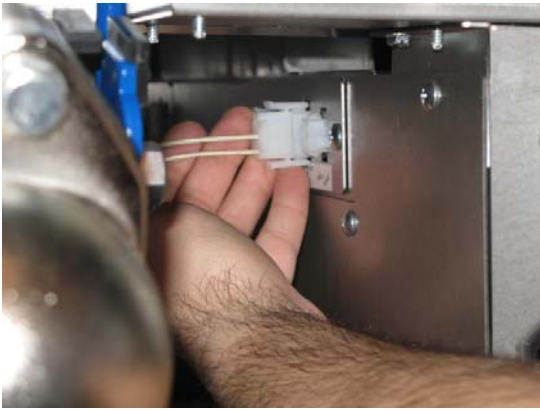

2. Connect the multimeter to the Hi-limit leads and check the resistance.



## Checking the Resistance of the Probe

---

1. Remove the probe connection.

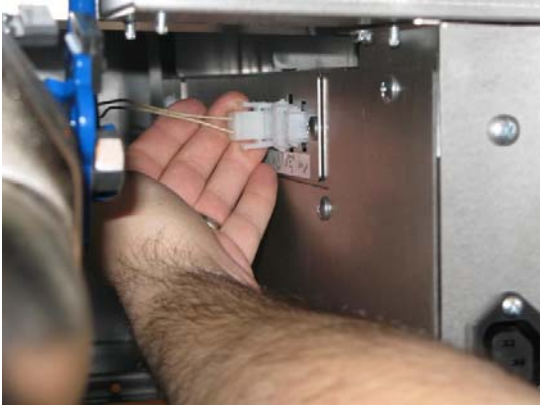

2. Connect the multimeter to the thermostat leads and check the resistance.



See “Probe Resistance Chart” on page 55.

## Replacing the Relay Board and Paper

---

1. Remove the front panel. See “Removing the Controller Front Panel Bezel” on page 12.
2. Remove the relay board. See “” on page 15.
3. Remove the relay board and flip it over.

4. Remove the existing insulator and replace with a new insulator.

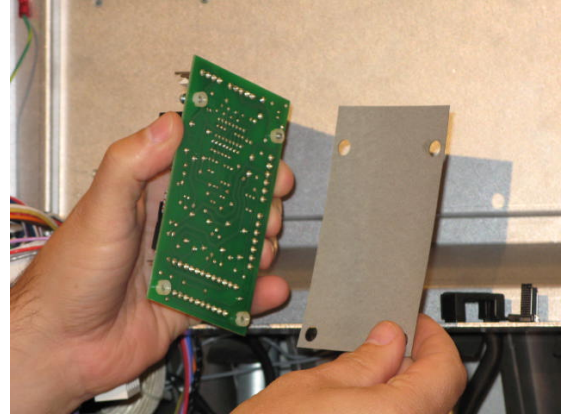

**NOTE: Make sure the insulator does not have puncture marks in it.**

5. Follow steps 1 through 2 to finish the replacement of relay board and paper.

## Replacing the Transformer

---

1. Remove the front panel (see “Removing the Controller Front Panel Bezel” on page 12), entrance box covers (see “Removing the Entrance Box Covers” on page 13), and entrance box wire guard (see “Removing the Entrance Box Wire Guard” on page 14).
2. Remove the four (4) terminal connections.

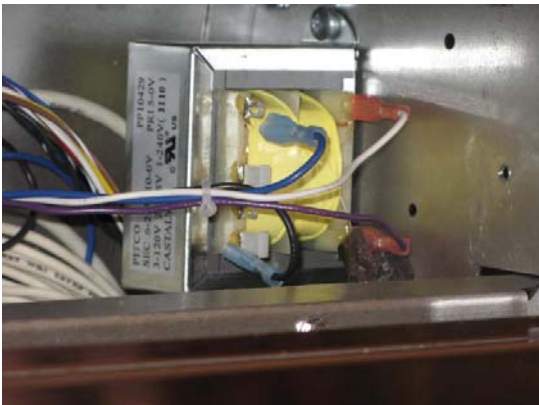

3. Remove the two (2) screws on the transformer box using a Philips screw driver.

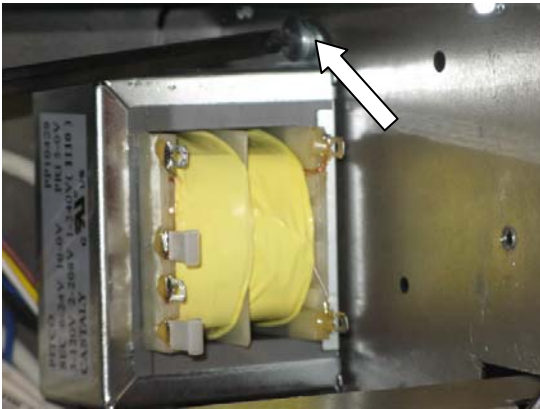

4. Remove transformer box from the unit.



#### Transformer Wiring

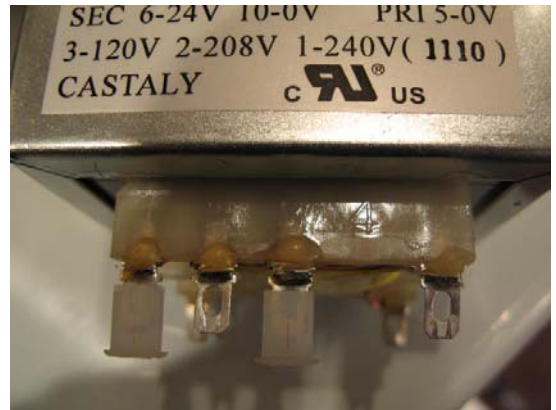

**NOTE: Wire according to the appropriate voltage.**

5. Follow steps 1 through 3 in reverse to install the new transformer.



## Replacing the DVI Switch

---

1. Remove the two (2) screws, which hold the proximity sensor on the drain handle, using a flathead screwdriver.

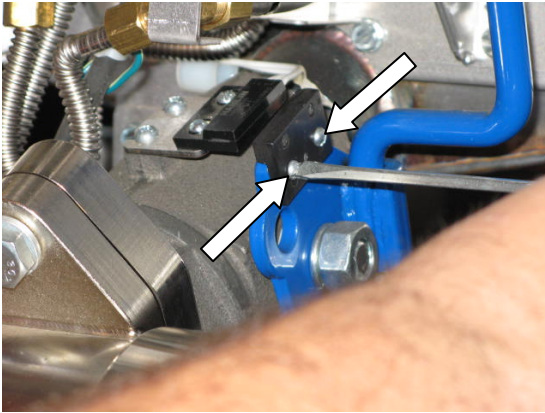

2. Loosen the two (2) screws, which hold the actuator, using a Philips screwdriver.

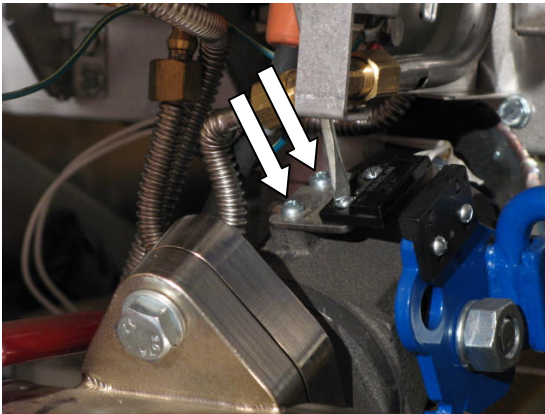

3. Unfasten the switch harness from the wire channel.

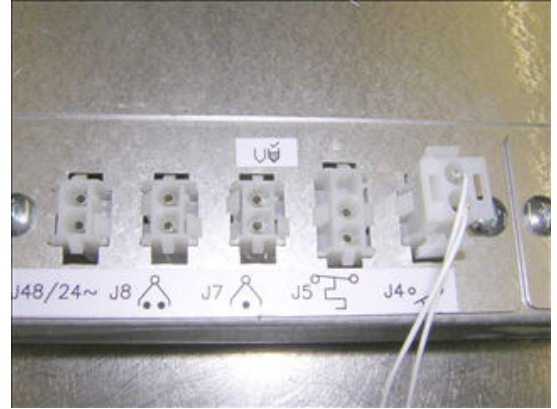

4. Remove the switch from mounting plate using a narrow tip flathead screwdriver.

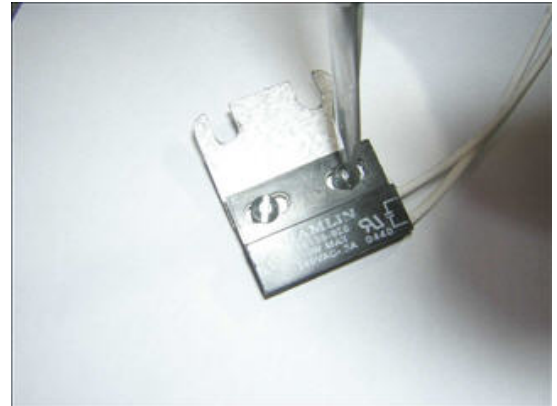

5. Replace the DVI switch ensuring a 1/4 inch gap between the actuator and the magnet.
6. Follow steps 1 through 3 in reverse to install a new DVI.

# Replacing the Safety Contactor

1. Remove the six (6) screws from the safety contactor using a flathead screwdriver.

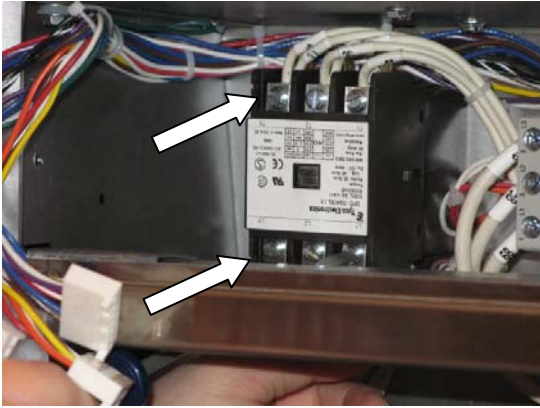

3. Remove the bottom screw on the safety contactor using a Philips screwdriver.

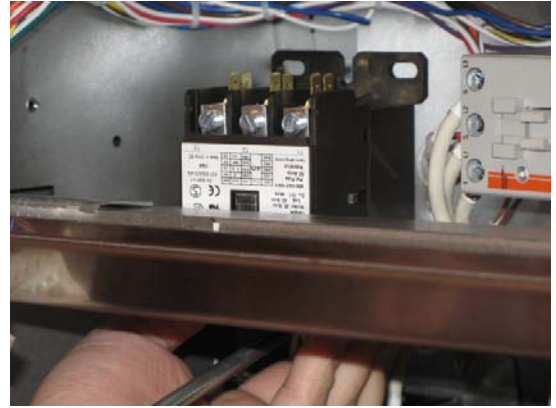

**Wires to Safety Contactor Connections Table**

Safety Contactor Connections	Wires
L1 (top)	1B
L2 (top)	2B
L3 (top)	3B
T1(bottom)	1D
T2 (bottom)	2D
T3 (bottom)	3D

4. Remove the safety contactor.



2. Loosen the top screw on the safety contactor using a Philips screwdriver.

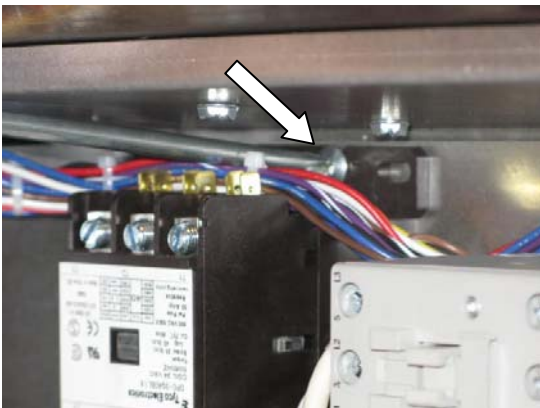

5. Follow steps 1 through 10 in reverse to finish the replacement of the new safety contactor.

## Replacing the HD Contactor

1. Remove the six (6) screws from the HD contactor using a Philips screwdriver.

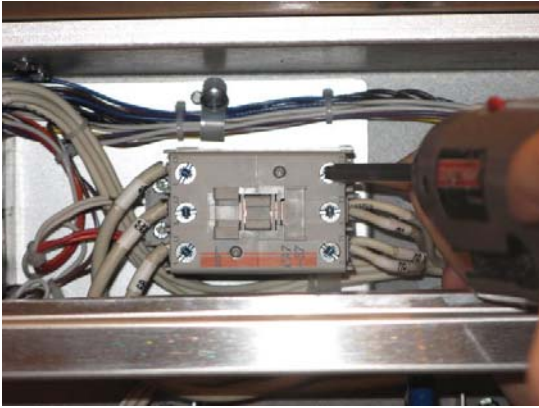

2. Remove the top screw on the mounting plate behind the HD contactor using a Philips screwdriver.

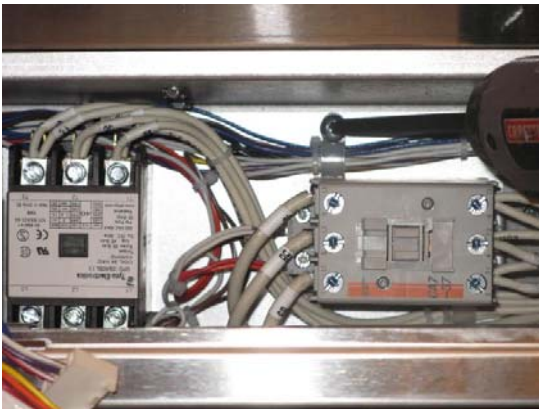

3. Cut the zip tie under the HD contractor to access the bottom screw on the plate.

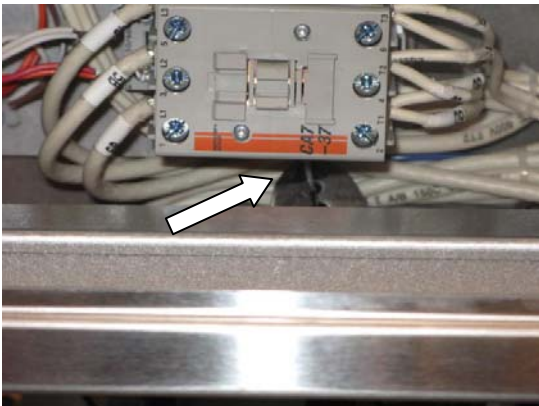

4. Remove the bottom screw on the mounting plate using a Philips screwdriver.

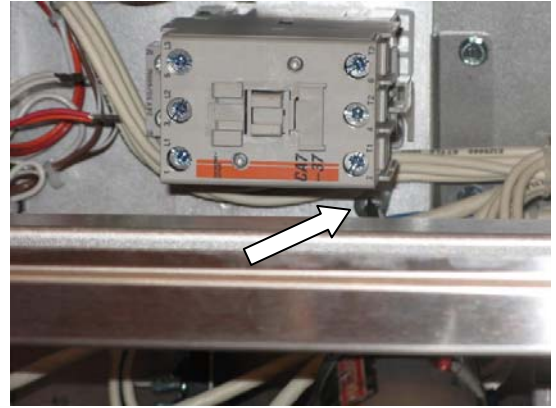

5. Remove the HD contactor.

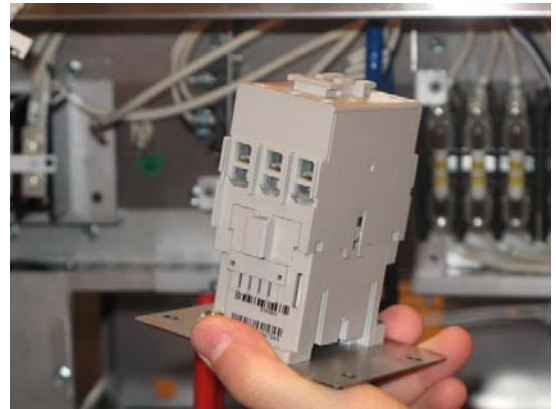

6. Remove the two (2) screws from the plate using a Philips screwdriver.



7. Follow steps 1 through 6 in reverse to finish the replacement of the new HD contactor.

## Replacing the Probe

1. Remove the basket hanger.



2. Remove one (1) of the screws from probe clamps using a Phillips screwdriver.

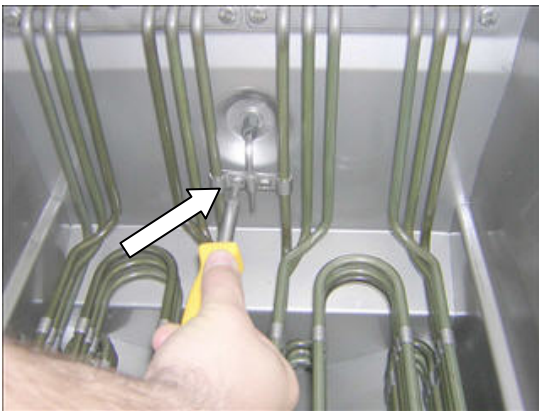

3. Loosen the other screw on the probe clamps, but do not remove it. Turn the rear probe clamp down and remove all three probe clamp pieces.

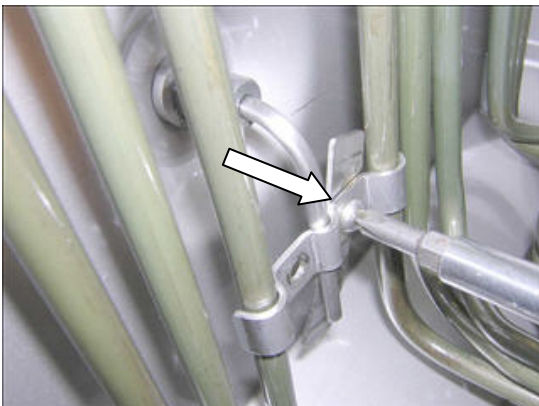

4. Remove the probe nut with 7/16 inch socket.

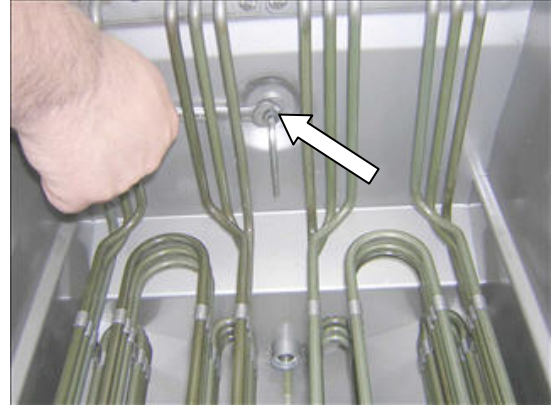

5. Cut the probe wires at the termination end connected to the entrance box wire channel.

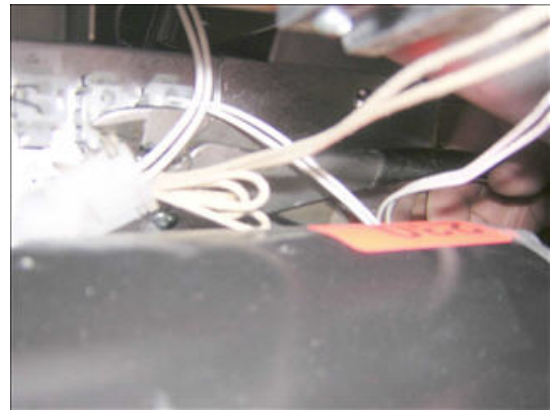

6. Pull the probe and wires through the tank fitting.

7. Slide the probe wires through the probe nut and ferrule, and then slide the probe nut and ferrule through the probe.



- Slide the probe wires through the tank fitting.



- Install the connectors onto the wires (black with black, and white with white).

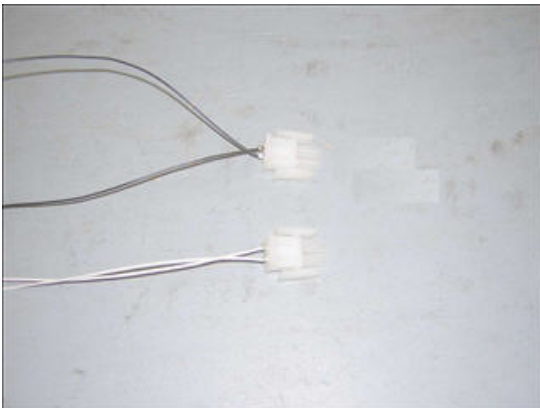

- Fasten the connectors to the wire channel.

**NOTE: Use the appropriate set of connections on the wire channel.**

**Full**

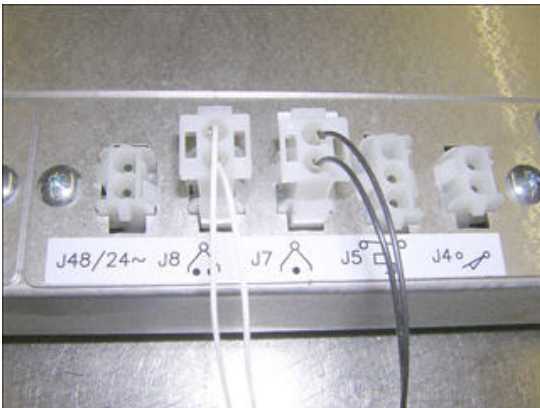

**Split**

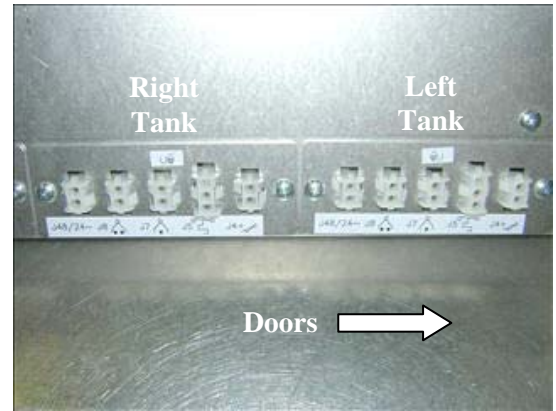

- Follow steps 1 through 4 in reverse to finish the replacement of the probe.

**NOTE: Be sure to leave at least 1 inch of probe exposed below probe clamps.**

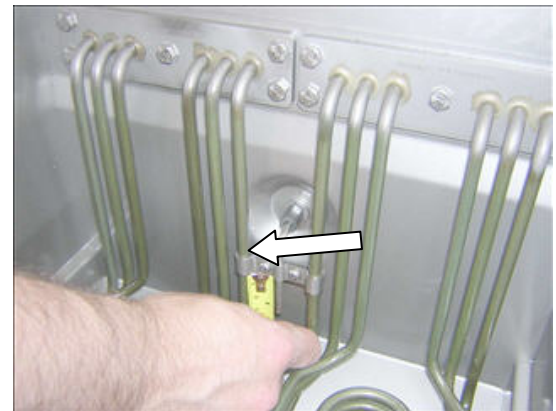

## Replacing the Hi-Limit

1. Remove the two (2) screws on the hi-limit clamp using a Phillips screwdriver.

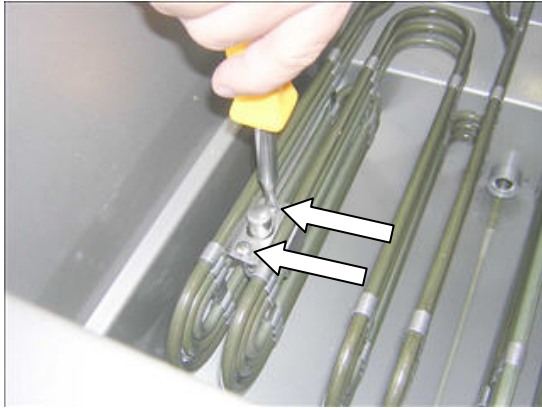

2. Remove the clamps.
3. Remove the hi-limit using a 7/8 inch socket.



4. Cut the probe wires at the termination end connected to the entrance box wire channel.

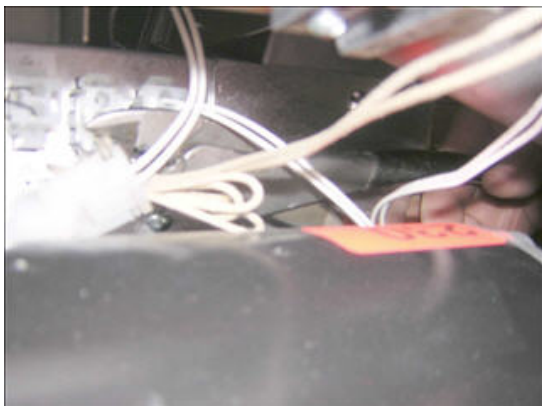

5. Pull the hi-limit and wires through the tank fitting.
6. Slide the wires of new hi-limit through the tank fitting and install a new hi-limit cartridge.
7. Install the hi-limit wires into the connector (pins 1 and 2) and fasten the connector to the wire channel.

**NOTE: Use the appropriate set of connections on the wire channel.**

### Full

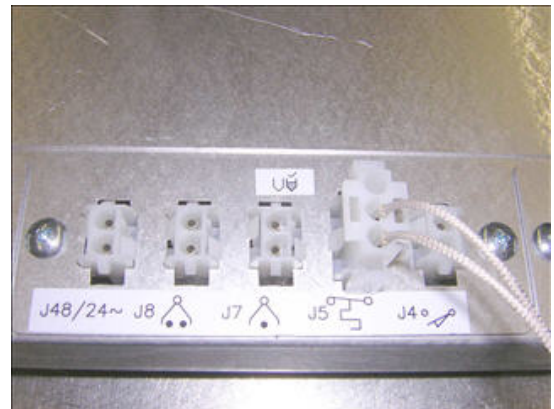

### Split

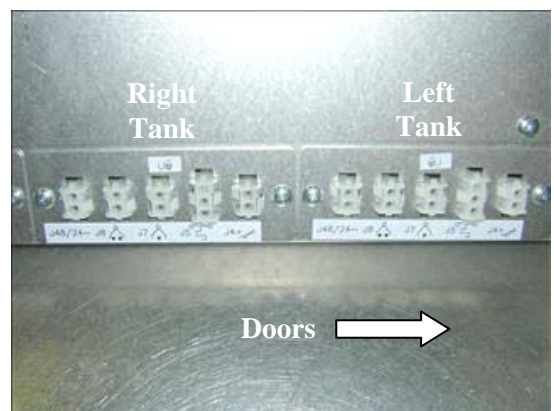

8. Follow steps 1 through 3 in reverse to finish the replacement of the hi-limit.

## Replacing the Element

---

1. Remove the basket hanger and probe clamps (see steps 1 through 3 in “Replacing the Probe” on page 28).

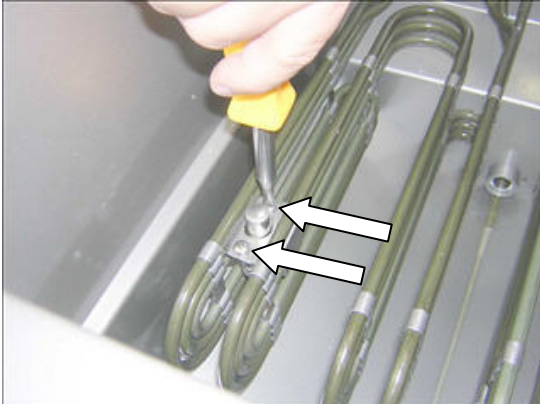

**NOTE: If replacing the left element of the SE14 tank, remove the hi-limit clamps (see step 1 in “Replacing the Hi-Limit” on page 30).**

2. Remove the five (5) element bolts using a 7/16 inch socket.

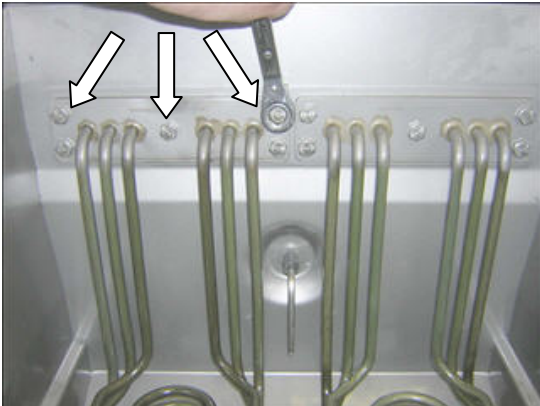

3. Push down on the front of the element, and pull out the back to expose the element supply wires.



4. Disconnect the element supply wires.

**NOTE: Do not let the wires fall back through the element mounting block.**



5. Remove the element.

6. Replace the element o-rings, if needed.



7. Follow steps 1 through 5 in reverse to finish the replacement of the new element.



## Replacing the Tank

---

1. Remove all the front panels (see “Removing the Controller Front Panel Bezel” on page 12), entrance box covers (see “Removing the Entrance Box Covers” on page 13), and entrance box wire guards (see “Removing the Entrance Box Wire Guard” on page 14).
2. Remove the top deck using a 5/16 inch hex wrench.



3. Remove the top deck heat shield using a 5/16 inch hex wrench.



4. Loosen the entrance box heat shield sides (top and bottom) using a 5/16 inch hex wrench.

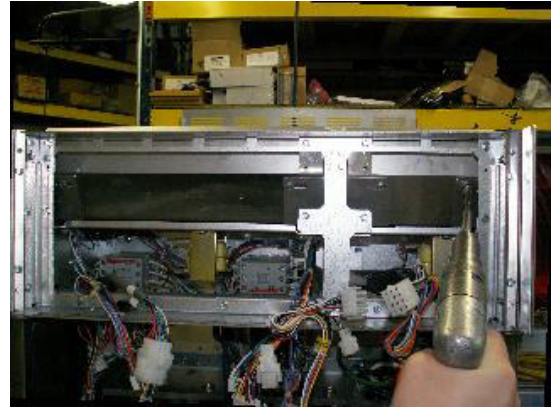

5. Slide the heat shield sides in enough to clear the cabinet sides during tank removal.



6. Disconnect and remove the power cords from the entrance box.

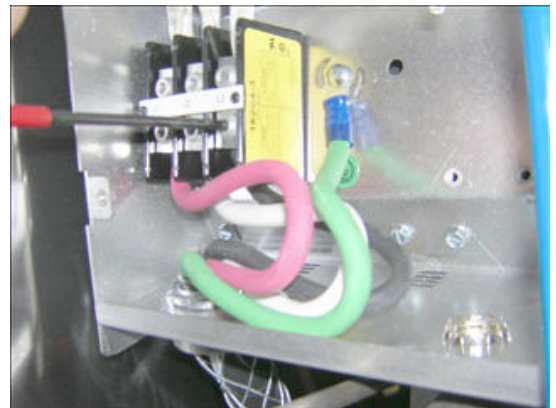

7. Loosen the four (4) drain elbow bolts using a 9/16 inch socket.



8. Slide the entire drain line assembly off of the drain extension nipples.
9. Remove the four (4) screws that hold down the entrance box using a 5/16 inch socket.

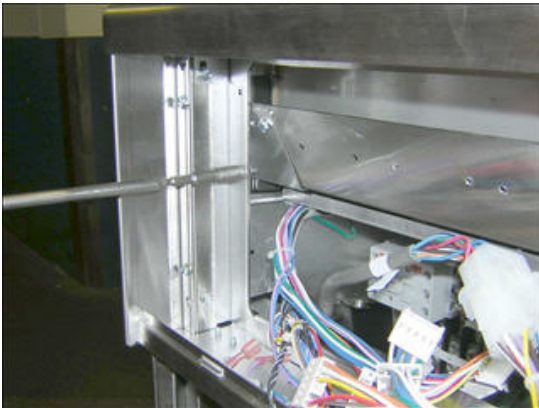

10. Disconnect the filter pump box power supply.

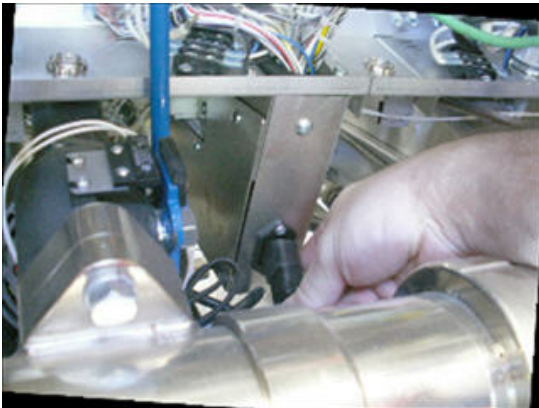

11. Disconnect the following connectors at the wire channel: DVI switch, probes, and hi-limit.



12. Remove the basket hangers.



13. Remove the six (6) screws, which hold the back of the splash back, using a 5/16 inch socket.



14. Remove the two (2) screws, which hold the front of the splash back, using a flathead screwdriver.



15. Remove the splash back by lifting up.
16. Remove the four (4) screws, which hold the cabinet back cover, using a 5/16 inch socket.



17. Disconnect all return hoses from the tank being replaced using an adjustable wrench.



18. Remove the cotter pin from filter return handle using needle-nose pliers and disconnect from 3-way return valve.

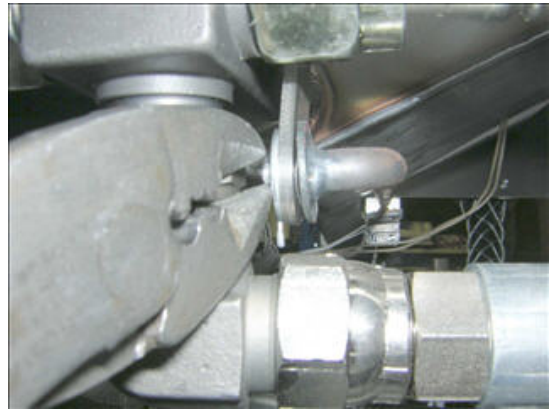

19. Remove the filter return handle clip and filter return handle using a 5/16 inch hex wrench.



20. Remove the six (6) screws (front and back), which hold the tank to the cabinet, using with a 5/16 inch socket.



21. Remove the channel strip by pulling up.



22. Score the silicon sealer between the tanks using a flathead screwdriver or utility knife.



23. Remove the elements in steps 1 through 5 in "Replacing the Element" on page 31.

**NOTE: Retain all removed clamps.**

24. Remove tank from cabinet.



25. Set tank on floor.

26. Remove the drain valve using a pipe wrench.



27. Remove the filter return valve using an adjustable wrench.



28. Remove the filter return valve adapter using an adjustable wrench.

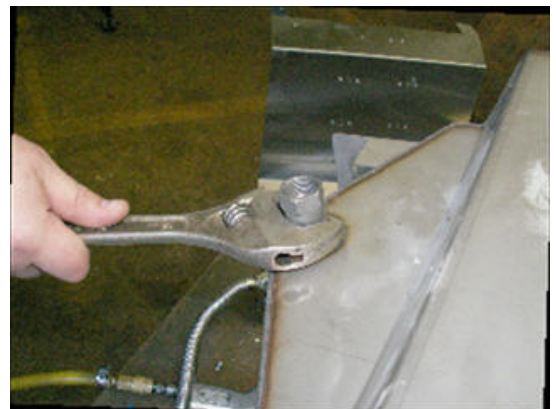

29. Remove the four (4) screws on the entrance box using a 5/16 inch socket.

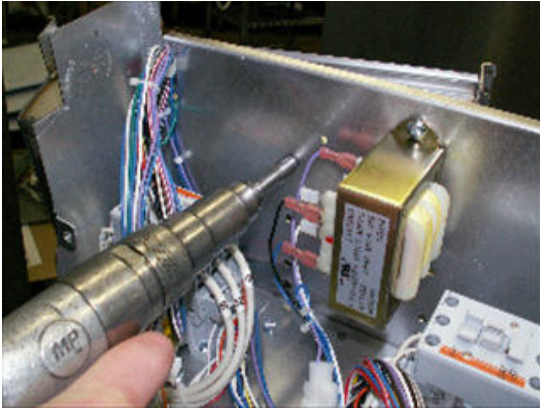

33. Remove the entrance box heat shields using a 5/16 inch hex wrench.



30. Remove the two (2) mounting screws on the wire channel using a Phillips screwdriver.



34. Follow steps 1 through 33 in reverse to install a new tank.

31. Remove the entrance box and wire channel assembly as one piece.

32. Remove the entrance box support brackets from entrance box heat shields using a 5/16 inch hex wrench.



# Filter System

## Replacing the Flush Hose Assembly and Valve

1. Remove the lower connection at the 3-way return valve in the back of the unit using a 15/16 inch wrench.

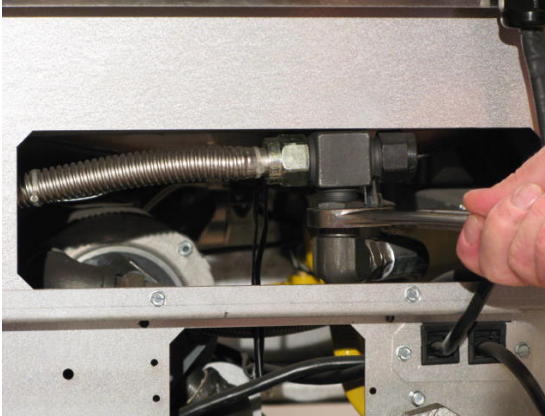

2. Remove the male quick disconnect using a 15/16 inch wrench.

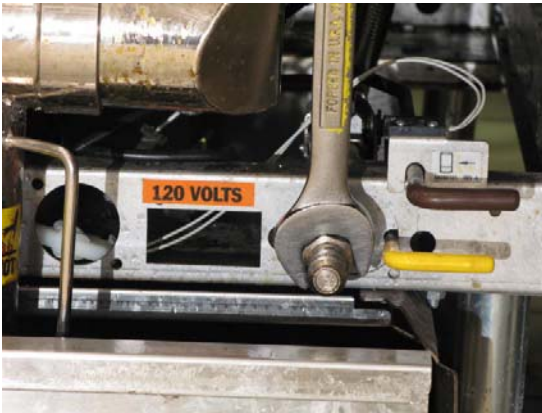

3. Unplug the proximity switch.

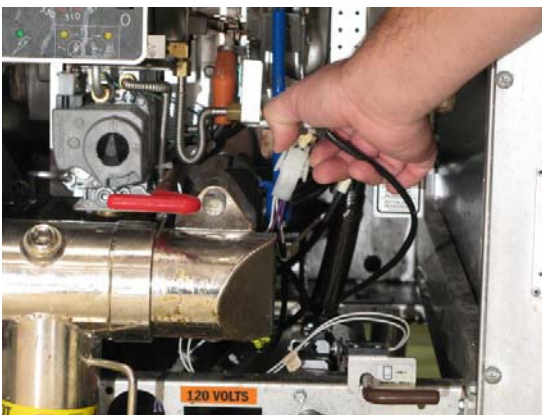

4. Remove two (2) screws holding the flush hose assembly using a 5/16 socket.

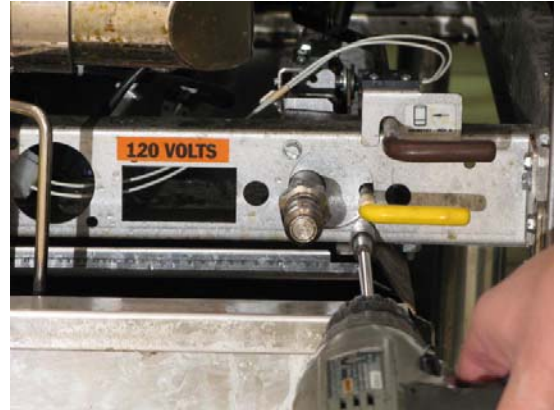

5. Remove the flush hose assembly.
6. Remove the four (4) screws from the magnets using a flathead screwdriver.

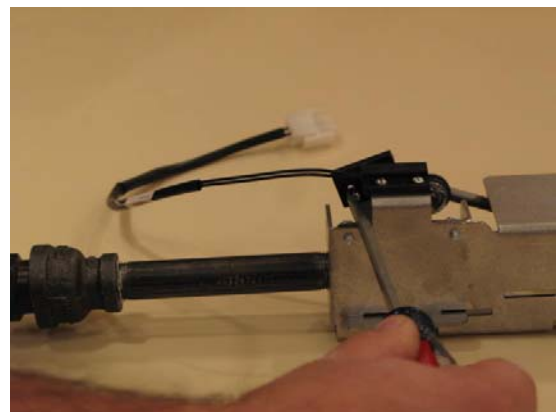
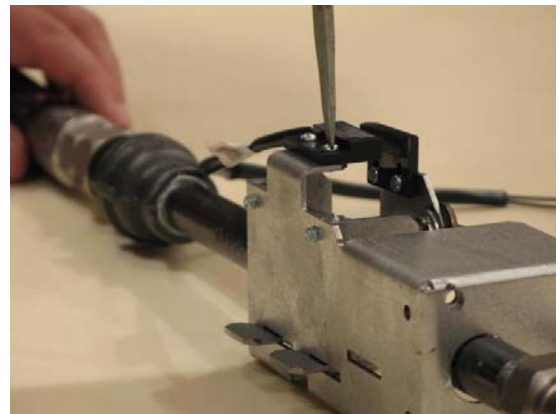

7. Remove the two (2) screws from the valve mounting brackets using a 5/16 socket.

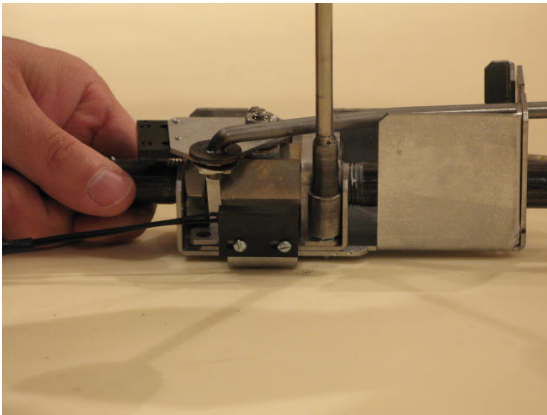
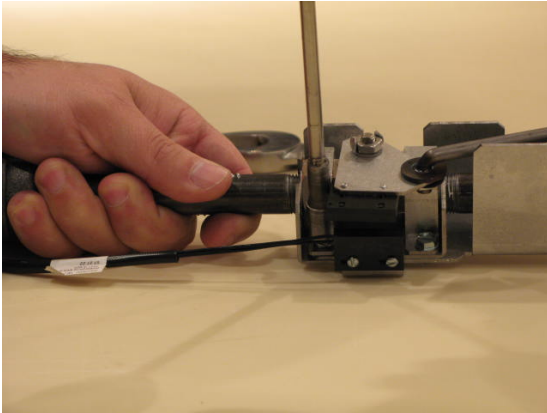

8. Slide the bracket to the back of the assembly.

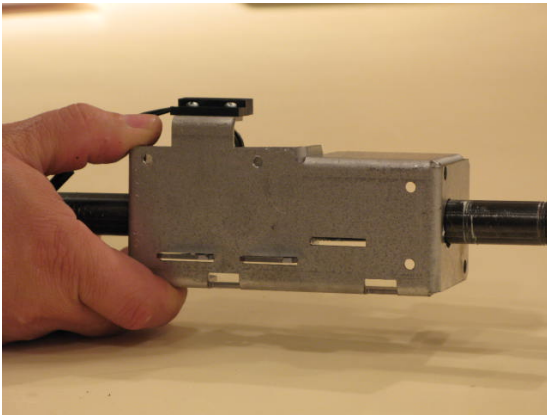

9. Lift bracket out and slide forward.

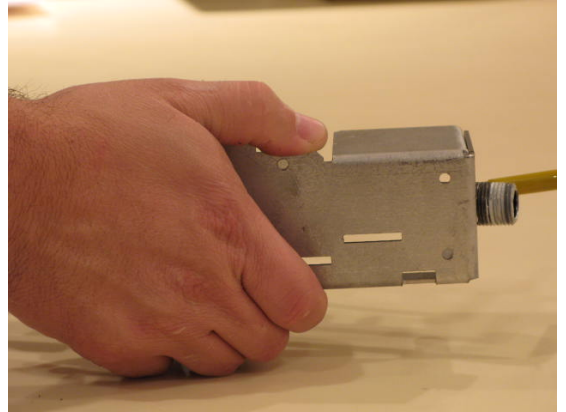

10. Bend down tabs of the stem nut washer using a needle-nose plier.

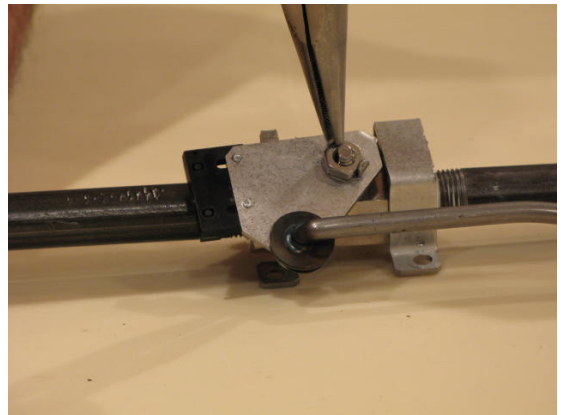

11. Remove the nut using a 7/16 inch wrench.

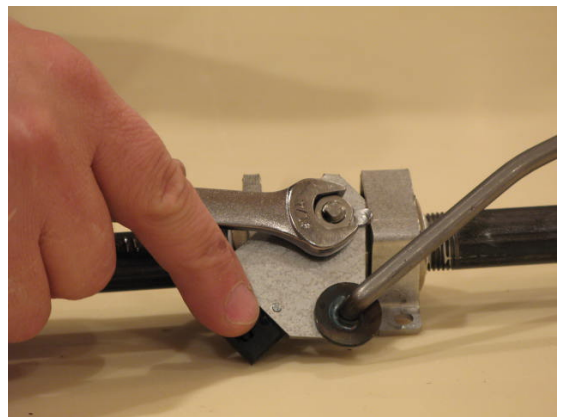



12. Remove the handle.

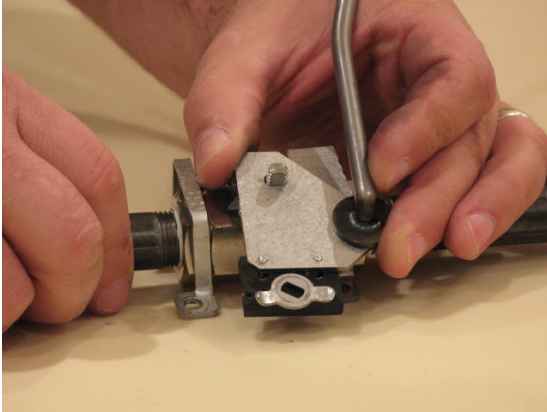

13. Remove the mounting bracket.

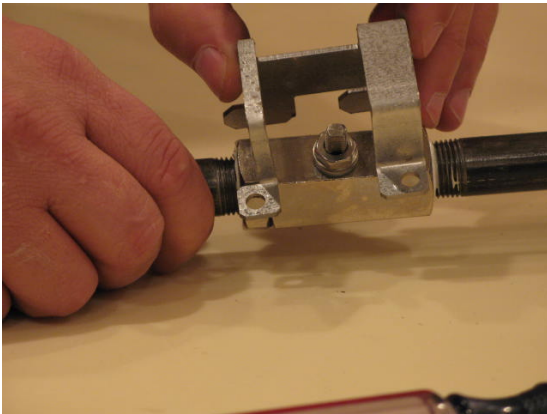

14. Remove the piping using a 15/16 inch wrench on the valve and an adjustable wrench on the piping.



15. Replace the flush hose assembly and valve by following steps 1 through 14 in reverse.

## Replacing the Filter Pump and Motor

### Removing the Filter Pump and Motor

1. Loosen the pump inlet tube using a crescent wrench.

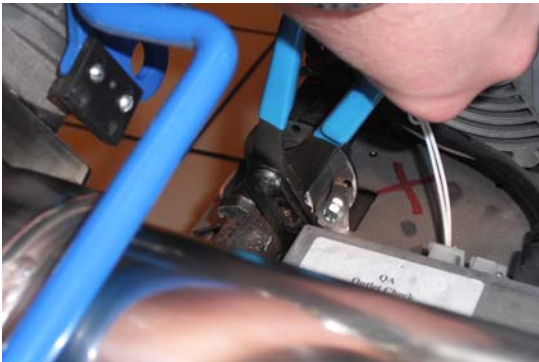
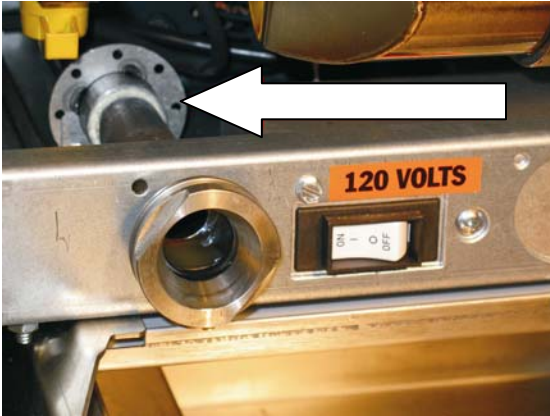

2. Unscrew and remove the inlet valve of the filter pump system.



3. Pull out pump inlet tube.



4. Remove filter pan cover (not shown).
5. Disconnect the connections and power supply cords from the filter pump.

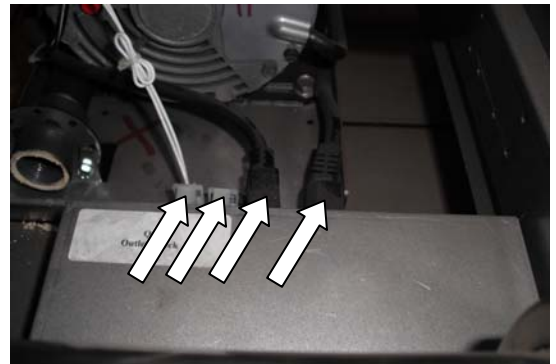

6. Remove the lower connection at the 3-way return valve using a 15/16 inch wrench.



7. Remove one (1) screw, which holds the bracket, using a 5/16 inch socket.



8. Remove the bracket.

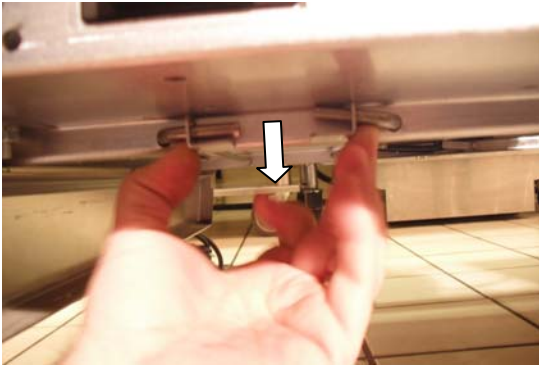

**NOTE: The filter pump will fall to the floor once the pins are pulled out. It is recommended that you brace the pump and motor before pulling out the pins.**

9. Turn down the pins and then pull them out.

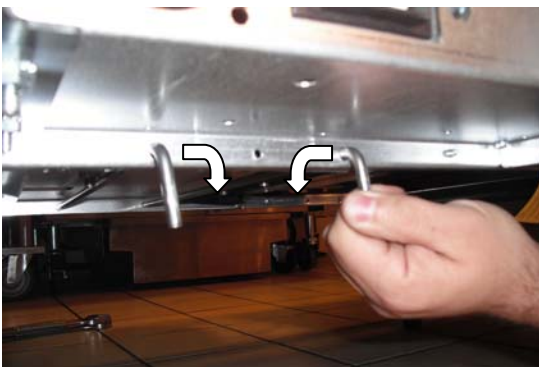

10. Lower the filter pump to the floor and then pull it out.

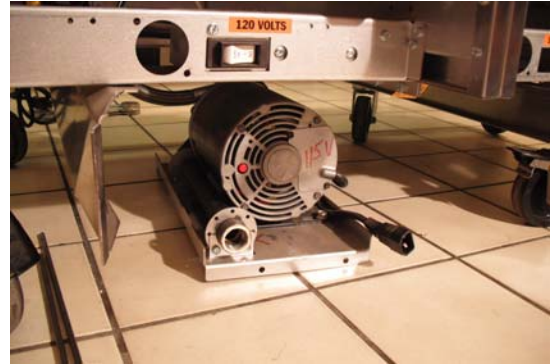

11. Remove the three (3) bolts on the bottom of the filter pump base using a 1/2 inch open-ended wrench.

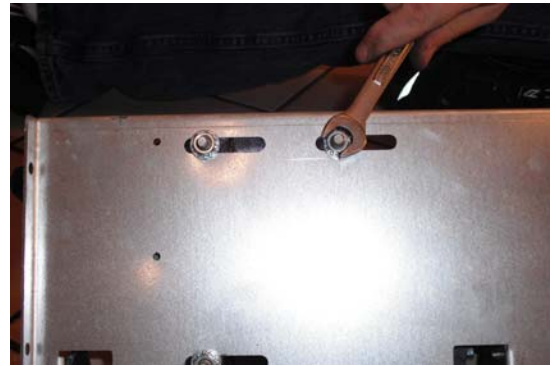

12. Remove two (2) screws on back of filter pump using a 5/16 inch socket.



13. Remove existing piping from old filter pump using two adjustable wrenches.



14. Reinstall a new filter pump by following steps 1 through 13 in reverse.

## Replacing Seal Kit

1. Remove the four (4) bolts on filter pump using 7/16 inch open-ended wrench.



2. Remove the filter pump head.



3. Replace the seal.

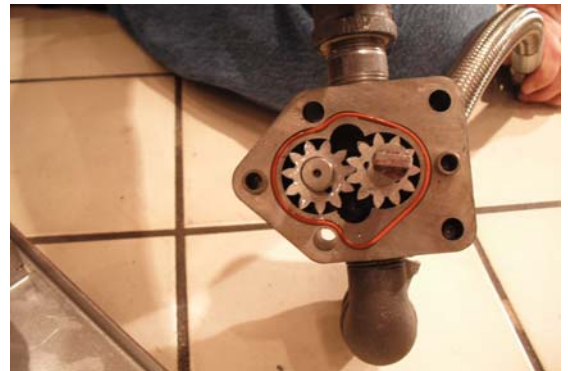

4. Reinstall the filter pump head to the motor by following steps 1 through 2 in reverse.

## Removing the Filter Pump from the Motor

---

1. Remove the two (2) bolts holding the filter pump head to the motor using a 1/2 inch open-ended wrench.



2. Remove the filter pump head from the motor.

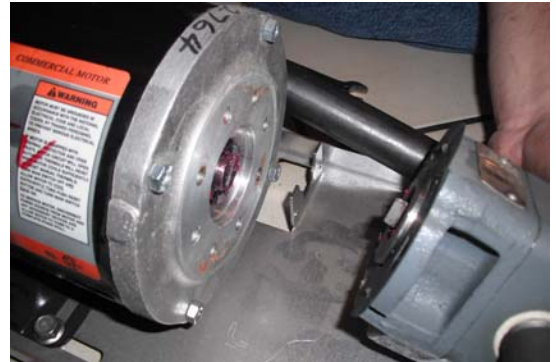

3. Reinstall the filter pump head to the motor by following steps 1 through 2 in reverse.

## Replacing the Pump Relay and Circuit Breaker

---

### Replacing the Circuit Breaker

---

1. Disconnect the connections and power supply cords from the filter pump.

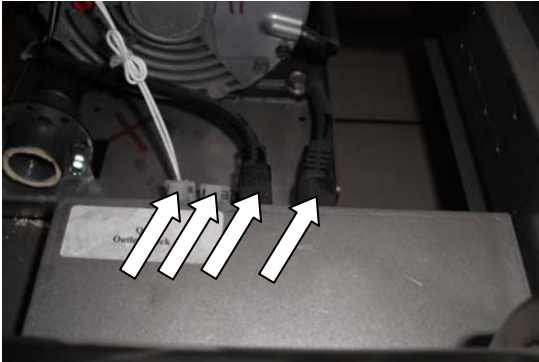

2. Remove the pump box.

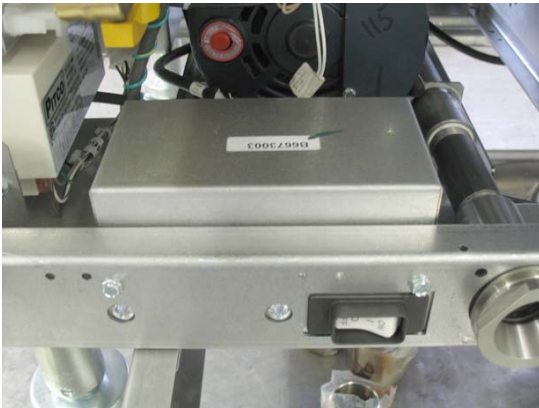

3. Remove the circuit breaker from the pump box.



4. Remove all wires on the circuit breaker using needle-nose pliers.



5. Squeeze the tabs on the circuit breaker and push it out.

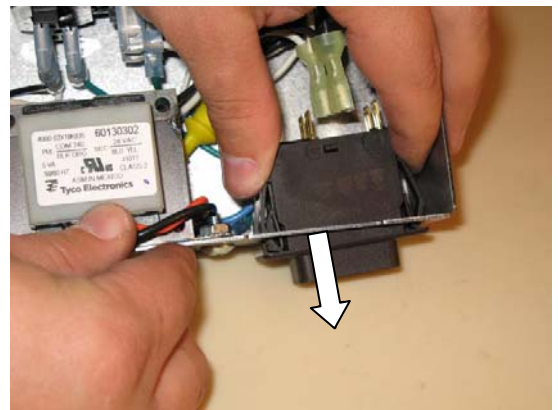

6. Reinstall the new circuit breaker by following steps 1 through 5 in reverse.

## Replacing the Pump Relay

---

1. Remove the two (2) screws, which hold the pump relay, using a Phillips screwdriver.



2. Remove all wires on the pump relay using needle-nose pliers. See “Wiring Schematics” on page 57.

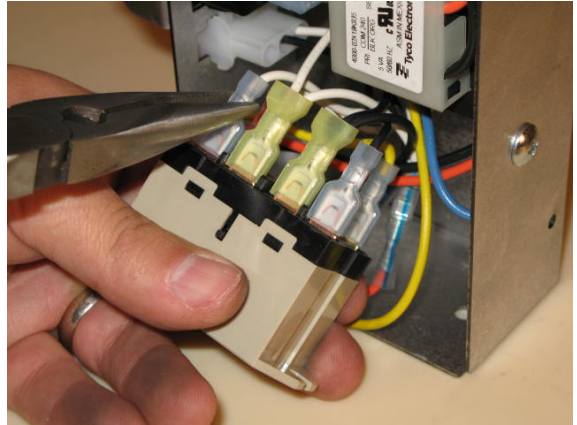

3. Remove the pump relay.
4. Reinstall the new pump relay by following steps 1 through 2 in reverse.

# Troubleshooting and Problem Isolation



# Troubleshooting and Problem Isolation

## Interpretation of Solid State Controller Lights

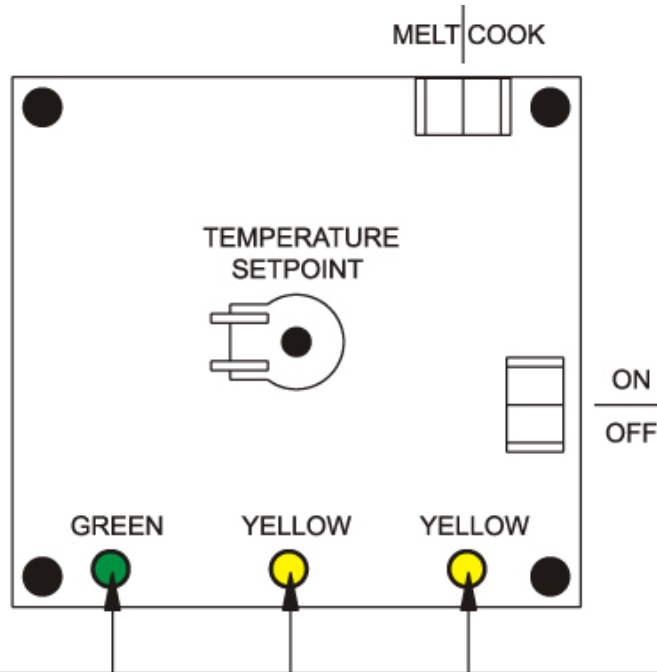

CONDITION	POWER SWITCH POSITION	POWER INDICATOR (GREEN)	HEAT DEMAND (YEL)	HEAT FEED BACK/FAULT (YEL)	DC OUTPUTS	
					SIDE ON	HEAT DEM
NORMAL OPERATION	OFF	OFF	OFF	OFF	OFF	OFF
	ON	ON	*ON AS REQUIRED	FOLLOWS HEAT DEM	ON	*ON AS REQUIRED
DRAIN SWITCH OPEN	OFF	OFF	OFF	7 FLASHES /PAUSE REPEAT	OFF	OFF
	ON	OFF	OFF		OFF	OFF
PROBE OPEN OR SHORTED	OFF	OFF	OFF	3 FLASHES /PAUSE REPEAT	OFF	OFF
	ON	OFF	OFF		OFF	OFF
HIGH LIMIT TRIPPED	ON	ON	ON	OFF	ON	ON

\*FOR VAT TEMPERATURES ABOVE SET POINT, HEAT DEMAND WILL BE OFF.

## Solid State Thermostat Field Calibration

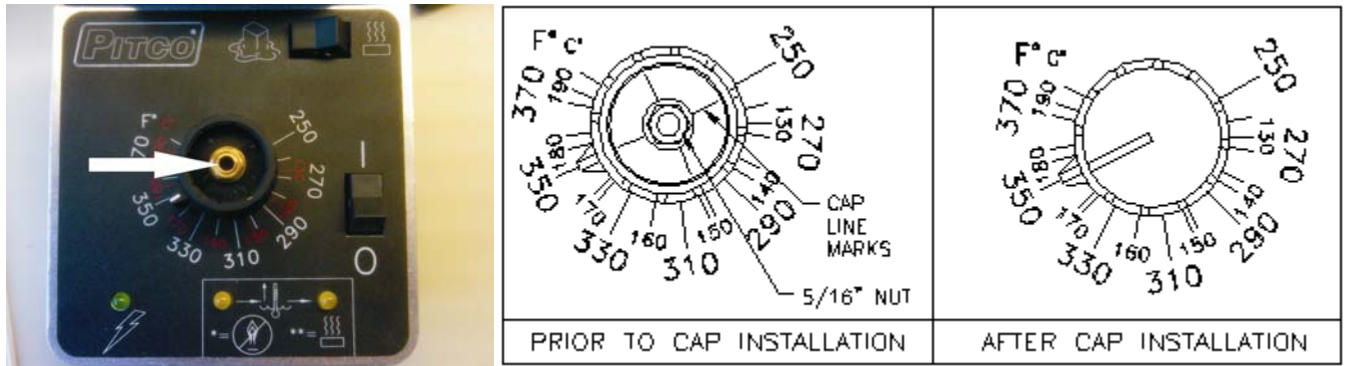

If field calibration is necessary, follow these steps:

1. Allow appliance to heat to set point, and then allow 30 minutes to stabilize.
2. Measure the vat center oil temperature and compare this with the knob pointer scale.
3. To reposition the knob, pry off the cap of the knob with a sharp knife blade.
4. Without turning the shaft, loosen the 5/16-inch compression nut and pull the knob off.
5. Re-install the knob with the pointer at the temperature indicated on the test thermometer.
6. Tighten the 5/16-inch compression nut and install the cap.

## Component Troubleshooting

---

The following sections provide troubleshooting information for the fryer components.

### Probe

---

- The resistance of the probe changes as the temperature changes. The resistance decreases as the temperature rises.
- The lower the temperature, the greater the resistance change is per degree of temperature change. As the temperature approaches the working range of the probe, the resistance change becomes more linear.
- If the probe is suspect, check its resistance and the oil temperature (as close to the probe as possible) at which it was taken. Compare these values to the values in the “Probe Resistance Chart” on page 55.
- If the probe returns an open circuit or a 0  $\Omega$  reading, replace it. If the resistance varies more than 30  $\Omega$  when checked in the range of 325°F to 375°F (163°C to 191°C), the probe gives a false temperature reading on the computer. Calibrate the probe up to 10°F or replace it; however, the probe continues to operate at a slightly higher or lower temperature. See “Probe Resistance Chart” on page 55.
- Allow the oil to cool and check the probe resistance at a lower temperature. Looking at the probe resistance chart, a greater resistance variation is tolerated at a lower temperature.

### HD Contactor

---

The HD contactor has a 24 VAC coil and energizes when the correct voltage is supplied to the coil. When energized, the contacts close, allowing current to flow through the elements. The coil resistance is 192  $\Omega$  out of current.

### Safety Contactor

---

Check the coil with an  $\Omega$  meter. The resistance should be approximately 3  $\Omega$  to 6  $\Omega$  out of circuit. If it does not have this resistance, it should be changed.

### Hi-Limit

---

The hi-limit switch is a closed switch until the temperature at the hi-limit bulb reaches 425°F  $\pm$ 20°F (232°C  $\pm$ 20°C). The oil temperature needs to drop approximately 45°F (7°C) before it resets. If it does not reset after the oil has cooled, it is defective.

**WARNING: THIS TEST SHOULD BE PERFORMED BY A QUALIFIED TECHNICIAN ONLY! MONITOR THE FRYER CLOSELY. THIS TEST WILL CAUSE THE OIL TO HEAT PAST THE NORMAL OPERATING TEMPERATURE AND CAN CAUSE DAMAGE TO THE MACHINE AND ITS OPERATOR IF CARE IS NOT TAKEN.**

**WARNING: THIS TEST WILL CAUSE THE ELEMENTS TO HEAT CONTINUOUSLY. REMOVE TEST RESISTOR WHEN TEST IS COMPLETE. LEAVING THE TEST RESISTOR IN THE FRYER COULD CAUSE DAMAGE TO THE EQUIPMENT AND/OR PERSONAL INJURY.**

To test the hi-limit, use a 2k $\Omega$  - 5 k $\Omega$  resistor to simulate a 230°F - 275°F temperature. This causes the elements to heat continuously until the hi-limit trips or the fryer is turned off.

- If testing with the computer, plug the resistor in at connector J41 behind the front panel.
- If testing with the back-up thermostat behind the door, plug the resistor in at connector J43 behind the front panel.

If the switch does not trip between the prescribed limits, it is defective and should be replaced. Once tripped, the switch cannot be reset until the oil has cooled to approximately 375°F  $\pm$ 20°F. If the switch does not reset after oil has cooled, it is defective.

## Drain Valve and Return Valve Switches

---

These switches are a magnetically operated proximity switches. When the BLUE drain valve handle is moved to the open position, the actuator moves away from the switch causing the switch to open. When the drain valve is closed, the switch closes.

Opening the RED filter return valve handle closes the proximity switch, causing the “pump on” relay to be energized; the pump begins to pump. Closing the filter return valve handle opens the proximity switch, causing the relay to de-energize and the pump to stop pumping. These switches can be checked with a  $\Omega$  meter. When the switch is closed, there should be continuity. The normal gap between the actuator and the sensor switch on the valve handle is 1/8 inch to 1/4 inch (3 mm to 6 mm).

## Transformer

---

The transformer is a multiple AC input voltage and 24 VAC output voltage. It can be checked by reading the input and output voltages. A quick check for 24 VAC is done at the relay board behind the front panel. The AC indicator is illuminated if the F1 fuse is good and the board is receiving 24 VAC.

## Elements

---

Each element has three coils. Check all the element coils out of circuit with an  $\Omega$  meter. The resistance should correspond to the following:

208 Volt Element	14.1-16.4 $\Omega$
240 Volt Element	18.8-21.8 $\Omega$

If the resistance is outside of the rating, the element needs to be changed. Also check for continuity to ground on each end of the suspect element. There should be no continuity to ground.

## Relay Board

---

**NOTE: J connectors are marked on the relay board.**

With 24 VAC supplied to pin #2 at connector J35 and a good F1 fuse, the relay board has a 24 VAC output at pin #2 on connectors J33 and J34 and the AC indicator is illuminated.

When the board receives a 24 VDC SO input at pin #7 on connector J31 or J33, the SO indicator is illuminated, the SO relay is energized, and there is a 24 VAC output at pin #4 on connector J32.

When the board receives a 24 VDC HD input at pin #6 on connector J31 or J33, the HD indicator is illuminated, the HD relay is energized and there is continuity between pin #1 and pin #2 at connector J32.

## Computer Control

---

**NOTE: All controller test points are at connector P/J1 (closest connector to the controller).**

With 24 VAC supplied to pin #1(24 VAC supply) and pin #5 (24 VAC input from DVI), the display reads “READY”.

When the controller is turned on, there is a 24 VDC output at pin #9 (SO).

When the controller calls for heat, there is a 24 VDC output at pin #8 (HD) and a 24 VAC input at pin #6 (HFB). If the HD contactor does not pull in, this indicates a break in the HD circuit.

To correct, do the following:

1. Check the hi-limit switch. Is it open or tripped?
2. Check the HD relay on the relay board. Is the HD relay energized, continuity through COM and NO contacts?
  - If display reads “PROBE OP” “OPEN”,  $\Omega$  test the temperature probe. Check the wires and connectors between the probe and controller for continuity.
  - If display reads “SYSTEM” “FAILURE”,  $\Omega$  test the temperature probe, and the wires and connectors between the probe and controller for a short.
  - If display reads “DRAINING” “TURN OFF”, verify that the drain valve is closed, check the proximity switch on the drain valve, turn the fryer off, and then turn the fryer on.

## Backup Solid State Control

---

The 24 VAC supply passes through the solid state back-up transfer switch to the computer. If the transfer switch is set to back-up or if the back-up controller has been unplugged, the primary controller will not work. A jumper must be installed on the relay board (connection J33, pin #2 to pin #10) to allow the primary controller to function if the back-up controller is removed.

24 VAC is supplied to the controller at pin #1 (24 VAC supply) and pin #5 (24 VAC input from DVI).

When the controller turned on, there is a 24 VDC output at pin #9 (SO) and the green indicator is illuminated.

When the controller calls for heat, there is a 24 VDC output at pin #8 (HD), the yellow indicator on the left is illuminated, and there is a 24 VAC input at pin #6 (HFB).

When the controller receives the 24 VAC input at pin #6, the yellow indicator on the right is illuminated. If the controller does not receive the 24 VAC input at pin #6, the indicator is not illuminated. This indicates a break in the HD or HFB circuit.

To correct, do the following:

1. Check the hi-limit switch. Is it open or tripped?
2. Check the HD relay on the relay board. Is the HD relay energized, continuity through COM and NO contacts?

- If the green and yellow indicators on the left illuminate on and off when the controller is turned on, this indicates an open or shorted probe or wires in between the probe and the controller.
- If none of the indicators illuminate when the controller is turned on, verify that the drain valve is closed and that the magnetic proximity switch has continuity when the drain valve is closed. Also verify that there is 24 VAC at pin #1 (24 VAC supply) and pin #5 (24 VAC input from DVI).

## Probe Resistance Chart

Probe Resistance in 5°F Increments.								
Probe Temp (°F)	Probe Temp (°C)	Resistance (Ohms)	Probe Temp (°F)	Probe Temp (°C)	Resistance (Ohms)	Probe Temp (°F)	Probe Temp (°C)	Resistance (Ohms)
10	-12.2	562734	175	79.4	11719	340	171.1	1058.23
15	-9.4	483875	180	82.2	10716	345	173.9	998.09
20	-6.7	417167	185	85.0	9812	350	176.7	942.00
25	-3.9	360589	190	87.8	8995	355	179.4	889.67
30	-1.1	312474	195	90.6	8255	360	182.2	840.78
35	1.7	271446	200	93.3	7586	365	185.0	795.10
40	4.4	236370	205	96.1	6979	370	187.8	752.38
45	7.2	206311	210	98.9	6427	375	190.6	712.41
50	10.0	180491	215	101.7	5926	380	193.3	674.95
55	12.8	158252	220	104.4	5470	385	196.1	639.87
60	15.6	139055	225	107.2	5055	390	198.9	606.96
65	18.3	122489	230	110.0	4675	395	201.7	576.09
70	21.1	108051	235	112.8	4329	400	204.4	547.09
75	23.9	95539	240	115.6	4013	405	207.2	519.86
80	26.7	84644	245	118.3	3723	410	210.0	494.24
85	29.4	75136	250	121.1	3458	415	212.8	470.16
90	32.2	66823	255	123.9	3214	420	215.6	447.49
95	35.0	59540	260	126.7	2991	425	218.3	426.13
100	37.8	53146	265	129.4	2785	430	221.1	406.02
105	40.6	47523	270	132.2	2597	435	223.9	387.04
110	43.3	42569	275	135.0	2422	440	226.7	369.14
115	46.1	38195	280	137.8	2262	445	229.4	352.24
120	48.9	34328	285	140.6	2113.9	450	232.2	336.29
125	51.7	30902	290	143.3	1977.3	455	235.0	321.21
130	54.4	27862	295	146.1	1851.0	460	237.8	306.94
135	57.2	25161	300	148.9	1734.3	465	240.6	293.46
140	60.0	22755	305	151.7	1626.1	470	243.3	280.69
145	62.8	20610	310	154.4	1525.9	475	246.1	268.61
150	65.6	18695	315	157.2	1433.0	480	248.9	257.15
155	68.3	16981	320	160.0	1346.7	485	251.7	246.30
160	71.1	15446	325	162.8	1266.6	490	254.4	236.00
165	73.9	14069	330	165.6	1192.1	495	257.2	226.24
170	76.7	12823	335	168.3	1122.8	500	260.0	216.96

**NOTE:** Resistance, of either probe lead, to the frame of the appliance should read as “open” on the meter.

Typically this is 1Meg ohms or more.

$$^{\circ}\text{C} = \frac{5}{9} (^{\circ}\text{F} - 32)$$

$$^{\circ}\text{F} = \left(\frac{9}{5} * ^{\circ}\text{C}\right) + 32$$

# Wiring Diagrams



## **Simplified Wiring Diagrams**

---



# US and Canada Wiring Diagrams (Replacement Parts List)

FILTER PUMP REPLACEMENT PARTS			
ITEM	VOLTAGE	DESCRIPTION	PART NO.
M1 (8GPM) VIKING	120V-50/60Hz	MOTOR AND PUMP 1/3HP 5GPM	60143501
	230V-50/60Hz		
	208V-50/60Hz	MOTOR AND PUMP 1/3HP 8GPM	60143503
	240V-50Hz		
M1 (8GPM) HAIGHT	208V-50/60Hz	MOTOR AND PUMP 1/3HP 8GPM	60130808
	120V-50/60Hz	MOTOR AND PUMP 1/3HP 8GPM	60130801
	230V-50/60Hz	MOTOR AND PUMP 1/3HP 8GPM	60130802
	240V-50Hz	MOTOR AND PUMP 1/3HP 8GPM	60130802
M3 (VIKING) VIKING MOTOR	115V-50/60Hz	MOTOR AND PUMP 1/3HP ZIF	60143511
	230V-50/60Hz		
	208V-50/60Hz	MOTOR AND PUMP 1/3HP ZIF	60143510
	240V-50/60Hz		
CB1 SEPARATE CORD NOTES 7,9	120V-50/60Hz	CKT BRKR, 10 AMP SINGLE POLE	60077901
	230V-50/60Hz	CKT BRKR, 5 AMP TWO POLE	60078502
	240V/50Hz		
CB1 MAINS CONNECT NOTES 8,10	220-240V 50/60Hz	CKT BRKR, 7 AMP TWO POLE UL 489 BCP	60078502
T3	120V-50/60Hz	XFMR, 120/24VAC 5VA	60130301
	230V-50/60Hz	XFMR, 240/24 VAC 5VA	60130302
	240V-50Hz		
K5	120V-50/60Hz	RELAY, 24VAC, 30A SPST	PP11058
	230V-50/60Hz	RELAY, 24VAC, 30A DPST	60104701
F2	ALL	FUSE 0.2A 250V TIME DELAY CERAMIC	60132701
FH2		FUSE HOLDER, IN LINE, .25 X 1.25	PP10765

CONTROLLER CONNECTIONS (P1)		
PIN	DESCRIPTION	
1	24VAC POWER IN	
2	24VAC COM POWER RETURN (CONNECTED TO FRAME GND)	
3	PROBE +	
4	PROBE -	
5	24VAC INPUT - DRAIN VALVE INTERLOCK	
6	24VAC INPUT - HEAT FEED BACK	
7	24VDC POWER RETURN	
8	24VDC OUTPUT - HEAT DEMAND	
9	24VDC OUTPUT - SIDE ON	
10	24VDC OUTPUT - BASKET LIFT RT	NOTE 1
11	24VDC OUTPUT - BASKET LIFT LFT	
12	24VACH TO PRIMARY CONTROLLER	NOTE 2

SHORTENING HEATER OPTIONS REPLACEMENT PARTS			
ITEM	VOLTAGE	DESCRIPTION	PART NO.
HTR4	120-50/60Hz	HEATER TAPE 1/2X 72", 50W	60133503
	230-50/60Hz		
	240/50Hz		
HTR5,6	120-50/60Hz	HEATER TAPE 1/2X 33", 25W	60133501
	230-50/60Hz		
	240/50Hz		

FRYER REPLACEMENT PARTS		
REF	DESCRIPTION	PART NO.
A1	DIGITAL TEMPERATURE CNTRL SINGLE	60126601
A1 (OPT)	DIGITAL TEMPERATURE CNTRL DUAL	60126701
A1 (OPT)	COMPUTER COOKING CNTRL SINGLE	60126801
A1 (OPT)	COMPUTER COOKING CNTRL DUAL	60126802
A3 (OPT)	BACKUP SSTC, W/MELT & DVI	60126401
A4	RELAY BOARD, 24VAC CLASS 2	60127301
A5	SOLID STATE TEMP CNTRL, W/MELT&DVI (PRIM)	60126301
K4	RELAY, 24VAC, 3PDT, 10A	60126001
HL1	SWITCH, HIGH LIMIT (DOMESTIC)	60141201
A2 (CE EXPORT)	HIGH LIMIT W/RESET ASSEMBLY CE	NEW
RT1 (NO BACKUP)	PROBE, NTC THERMISTOR PROBE	60140601
RT2 (W/BACKUP)	PROBE, NTC THERMISTOR DUAL PROBE	60141601
A10	POWER ON RESET CKT, 24VAC	60143301
LS1, LS4 (TYPICAL)	SWITCH PROXIMITY MAGNETIC	PP10282
	SWITCH ACTUATOR MAGNETIC	PP10283
FS1	SWITCH, FLOAT (OPTIONAL)	PS047217
T1A	XFMR, 120-208-240/24VAC 80VA CLASS 2	PP10428
T1B	XFMR, 380-440-480/24VAC 80VA CLASS 2	PP10429
F1	FUSE 2.5A 250V FAST ACTING	60132703
K10	CONTACTOR, 40A RES, 24VAC COIL, TABS	PP10580
K11	CONTACTOR, 3 POLE, 50A 690V, IEC	60139201
HTR1-3, 4-6	HTR, ELEMENT 7.0 KW, 208V	50006609
	HTR, ELEMENT 8.5 KW, 208V	50006601
	HTR, ELEMENT 11 KW, 208V	50006605
	HTR, ELEMENT 7.0 KW, 220V	50006610
	HTR, ELEMENT 8.5 KW, 220V	50006602
	HTR, ELEMENT 11 KW, 220V	50006606
	HTR, ELEMENT 7.0 KW, 230V	50006611
	HTR, ELEMENT 8.5 KW, 230V	50006614
	HTR, ELEMENT 11 KW, 230V	50006615
	HTR, ELEMENT 7.0 KW, 240V	50006612
	HTR, ELEMENT 8.5 KW, 240V	50006603
	HTR, ELEMENT 11 KW, 240V	50006607
	HTR, ELEMENT 7.0 KW, 480V	50006613
	HTR, ELEMENT 8.5 KW, 480V	50006604
HTR, ELEMENT 11 KW, 480V	50006608	

NOTES:

- STANDARD CONTROL (A5) MOUNTS BEHIND FRONT DOOR AND CONNECTS AT P3. BACKUP T-STAT AND BASKET LIFT OPTIONS ARE NOT AVAILABLE WITH STANDARD CONTROL.
- WHERE OPTIONAL CONTROL (A1) IS SUPPLIED, 24VAC (J3-12) IS SWITCHED ON/OFF BY OPTIONAL BACKUP T-STAT (A3). IF NO BACKUP OPTION IS SUPPLIED, INSTALL JUMPER BLOCK AT J33.
- CONTROL WIRING IS UL TYPE AWM, 300V, 105°C, UNLESS NOTED. CONTROL WIRING IS 18 AWG UNLESS NOTED WITH COLOR.
- WIRES 1A THROUGH 6D ARE 600V, 150°C, UL STYLE 3604/CSA AWM CLASS1 GROUP A/B. WHERE FUSES ARE SUPPLIED, WIRES 1A-6A ARE 10 AWG. FOR SE14\* AND SE18\*, WIRES 1B-3C ARE 10 AWG FOR ALL VOLTAGES. REMAINING WIRE SIZES ARE 14 AWG.
- SHEET 1 IS TYPICAL LOW VOLTAGE CONTROL WIRING FOR A SINGLE VAT. WHERE DUAL VAT TANK IS SUPPLIED, RIGHT SIDE CONTROL CIRCUIT IS IDENTICAL.
- DRAIN VALVE SWITCH IS CLOSED WHEN VALVE IS CLOSED.
- J. PHASE 440 AND 480 VAC LIMITS: OPTIONAL FILTER PUMP OR BASKET LIFT REQUIRE A SEPARATE SINGLE PHASE POWER SUPPLY AT 115/230-240VAC 50/60HZ. LINE CORDS ARE UL TYPE SJT/O, WIRE GAUGE (AWG) AS SHOWN. PLUG AND CORD SUPPLIED BY OTHERS.
- J. PHASE 208-240 VAC LIMITS: CONTROLS AND ALL OPTIONS ARE POWERED FROM L1 AND L2 (DELTA CONNECTED UNITS) OR L1 AND NEUTRAL (Y CONNECTED UNITS). ADD 4 AMPS TO HEATER CURRENTS SHOWN IN TABLES FOR CABINET WITH FILTER PUMP INSTALLED.
- SINGLE PHASE 440 AND 480 VAC LIMITS: OPTIONAL FILTER PUMP OR BASKET LIFT REQUIRE A SEPARATE SINGLE PHASE POWER SUPPLY AT 115/230-240VAC 50/60HZ. LINE CORDS ARE UL TYPE SJT/O, WIRE GAUGE (AWG) AS SHOWN. PLUG AND CORD SUPPLIED BY OTHERS.
- SINGLE PHASE 208-240 VAC LIMITS: CONTROLS AND ALL OPTIONS ARE POWERED FROM LINE (L) AND NEUTRAL (N). ADD 4 AMPS TO HEATER CURRENTS SHOWN ON TABLES FOR CABINET WITH FILTER PUMP INSTALLED.

# US and Canada Wiring Diagrams (Basket Lift Option)

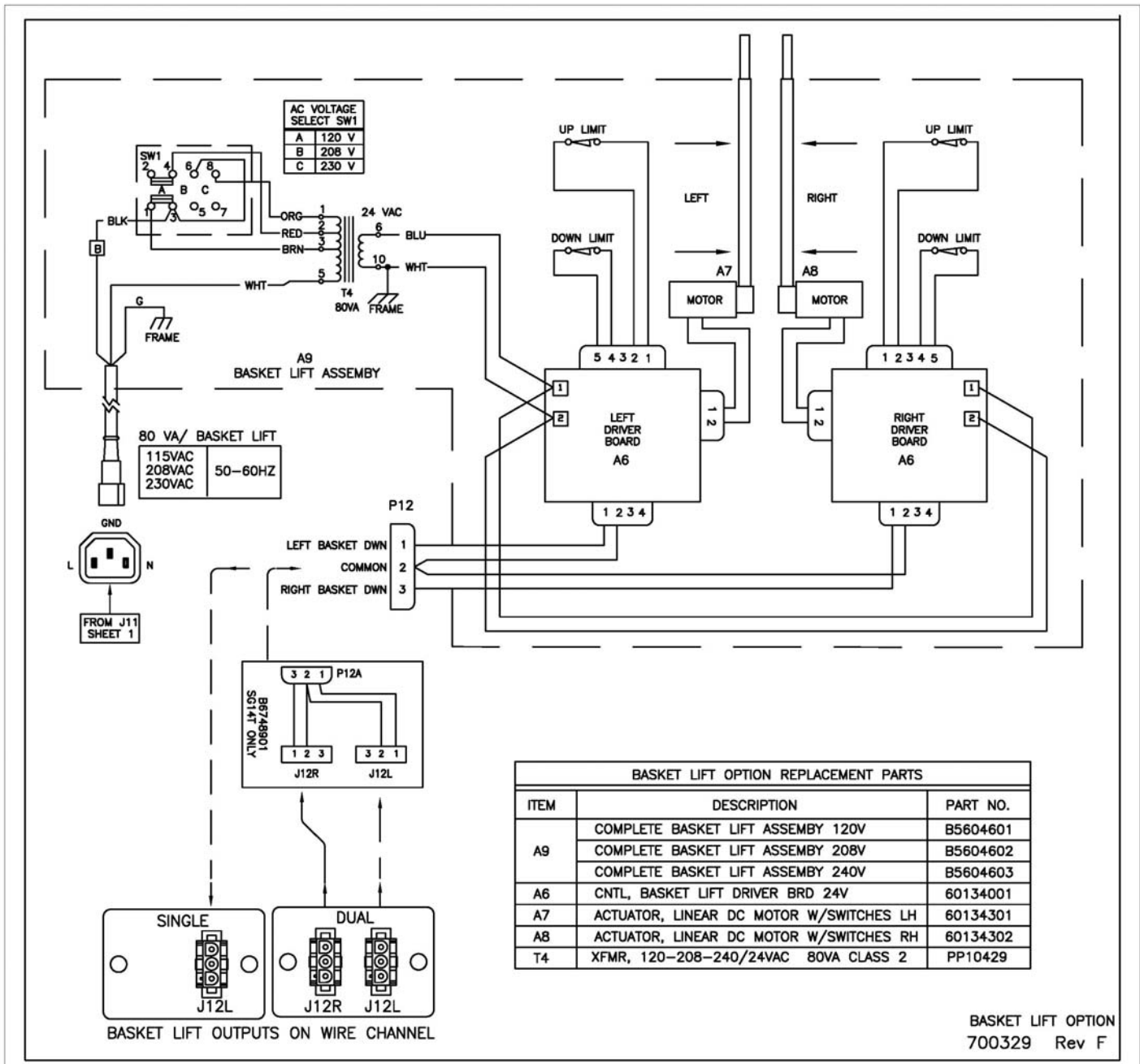

# US and Canada Wiring Diagrams (Filter Pump Option)

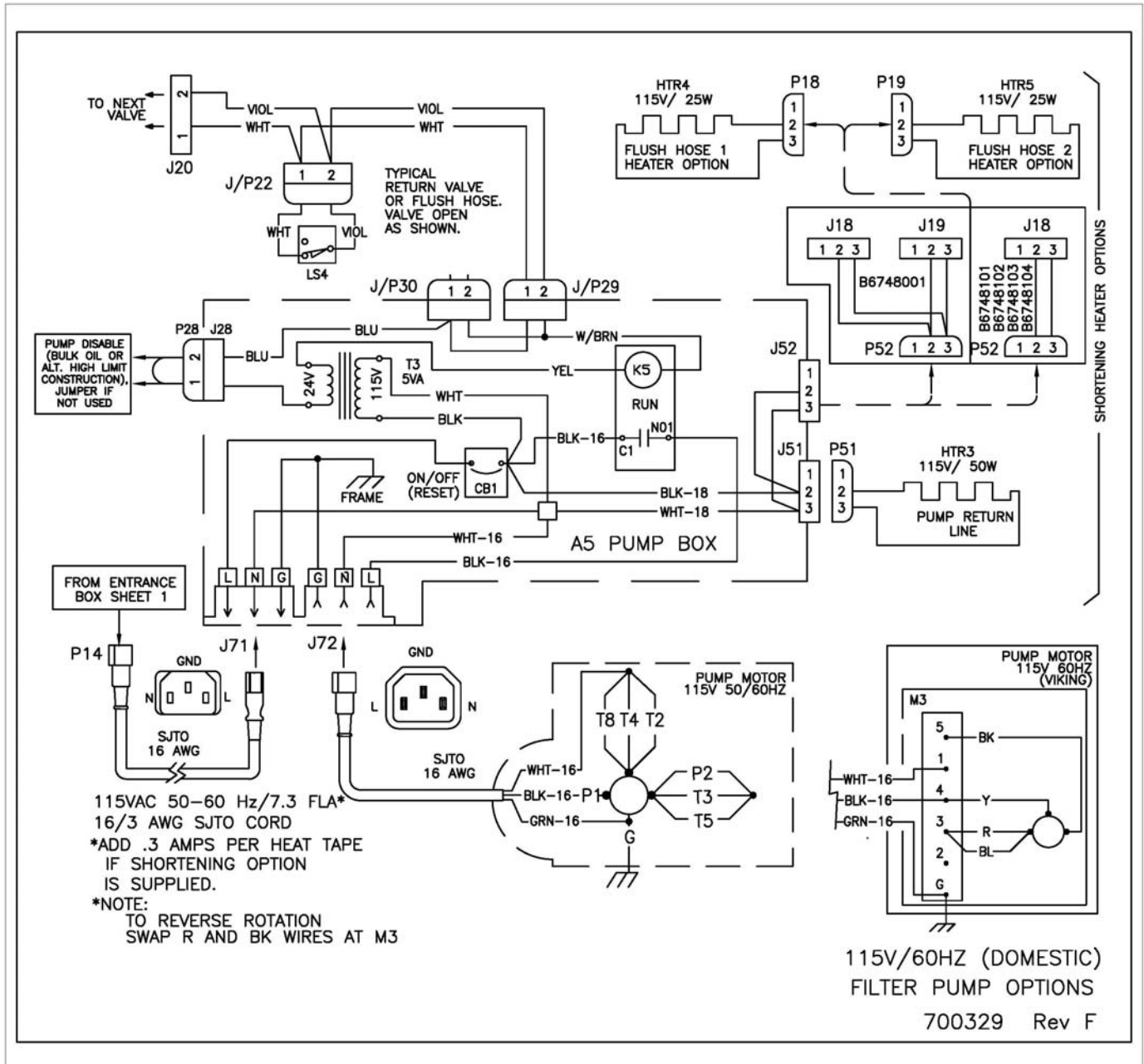

# US and Canada Wiring Diagrams (Single Phase Twin Vat)

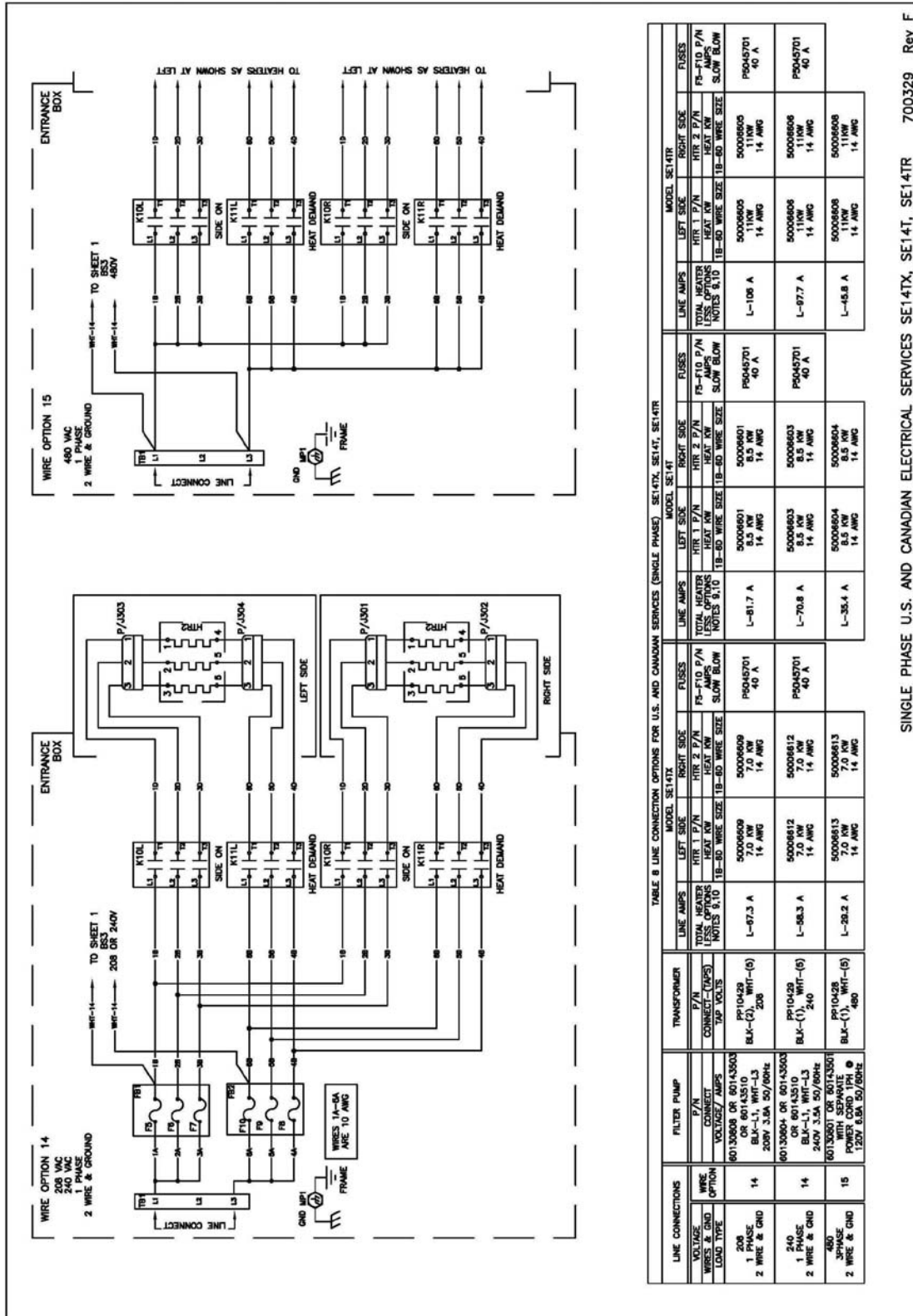

SINGLE PHASE U.S. AND CANADIAN ELECTRICAL SERVICES SE14TX, SE14T, SE14TR 700329 Rev F

# US and Canada Wiring Diagrams (Single Phase Full Vat)

**WIRE OPTION 12**  
208 VAC  
240 VAC  
1 PHASE  
2 WIRE & GROUND

**WIRE OPTION 13**  
480 VAC  
240 VAC  
3 PHASE  
3 WIRE & GROUND

**TABLE 6A LINE CONNECTION OPTIONS FOR U.S. AND CANADIAN SERVICES (SINGLE PHASE) SE14X, SE14, SE14R, SE14R**

LINE CONNECTIONS	VOLTAGE PHASES & GND	WIRE OPTION	FILTER PUMP P/N	CONNECT	TAP VOLTS	MODEL SE14X			MODEL SE14			MODEL SE14R		
						LINE AMPS	NOTES	9,10	LINE AMPS	NOTES	9,10	LINE AMPS	NOTES	9,10
208 1 PHASE 2 WIRE & GND	12	12	80130808, 60143503 OR 60143510 BLK-L1, WHT-L3 240V 3.5A 50/60Hz	PP10429 BLK-(2), WHT-(5) 208	50006609	L-87.3 A	50006609	L-81.7 A	50006601	L-106 A	50006605	L-106 A		
240 1 PHASE 2 WIRE & GND	12	12	80130804, 60143503 OR 60143510 BLK-L1, WHT-L3 240V 3.5A 50/60Hz	PP10429 BLK-(1), WHT-(5) 240	50006612	L-58.3 A	50006612	L-70.8 A	50006603	L-92 A	50006607	L-92 A		
480 1 PHASE 2 WIRE & GND	13	13	80130801 OR 60143501 WITH SEPARATE POWER CORD 1PH 3 120V 6.5A 50/60Hz	PP10428 BLK-(1), WHT-(5) 480	50006613	L-29.2 A	50006613	L-35.4 A	50006604	L-45.8 A	50006608	L-45.8 A		

**TABLE 6B LINE CONNECTION OPTIONS FOR U.S. AND CANADIAN SERVICES (SINGLE PHASE) SE18X, SE18, SE18R**

LINE CONNECTIONS	VOLTAGE PHASES & GND	WIRE OPTION	FILTER PUMP P/N	CONNECT	TAP VOLTS	MODEL SE18X			MODEL SE18			MODEL SE18R		
						LINE AMPS	NOTES	9,10	LINE AMPS	NOTES	9,10	LINE AMPS	NOTES	9,10
208 1 PHASE 2 WIRE & GND	12	12	80130808, 60143503 OR 60143510 BLK-L1, WHT-L3 208V 3.5A 50/60Hz	PP10429 BLK-(2), WHT-(5) 208	50006609	L-87.3 A	50006609	L-81.7 A	50006601	L-106 A	50006605	L-106 A		
240 1 PHASE 2 WIRE & GND	12	12	80130804, 60143503 OR 60143510 BLK-L1, WHT-L3 240V 3.5A 50/60Hz	PP10429 BLK-(1), WHT-(5) 240	50006612	L-58.3 A	50006612	L-70.8 A	50006603	L-91.7 A	50006607	L-91.7 A		
480 1 PHASE 2 WIRE & GND	13	13	80130801 OR 60143501 WITH SEPARATE POWER CORD 1PH 3 120V 6.5A 50/60Hz	PP10428 BLK-(1), WHT-(5) 480	50006613	L-29.2 A	50006613	L-35.4 A	50006604	L-45.8 A	50006608	L-45.8 A		

SINGLE PHASE U.S. AND CANADIAN ELECTRICAL SERVICES  
FOR MODELS SE14X, SE14, SE14R, SE18X, SE18, SE18R  
700329 Rev F

# US and Canada Wiring Diagrams (3 Phase Full Vat)

**WIRE OPTION 1**  
208 VAC  
3 PHASE  
3 WIRE & GROUND  
(DELTA CONNECT)

ENTRANCE BOX

TO SHEET 1  
ESS3  
480V

WIR-14

MP1

FRAME

HEAT DEMAND

RIGHT SIDE

LEFT SIDE

**TABLE 2A LINE CONNECTION OPTIONS FOR U.S. AND CANADIAN SERVICES SE14X, SE14, SE14R**

LINE CONNECTIONS	VOLTAGE WIRES & GND LOAD TYPE	WIRE OPTION	FILTER PUMP P/N CONNECT VOLTAGE/AMPS	TRANSFORMER P/N CONNECT-(TAP) TAP VOLTS	MODEL SE14X			MODEL SE14R		
					TOTAL HEATER LESS OPTIONS NOTES 7/8	HTR1, HTR2 TOTAL HEAT KW 1A-3C WIRE SIZE	FUSES FS-F7 P/N AMPS	TOTAL HEATER LESS OPTIONS NOTES 7/8	HTR1, HTR2 TOTAL HEAT KW 1A-3C WIRE SIZE	FUSES FS-F7 P/N AMPS
208 3 PHASE 3 WIRE & GND DELTA	1	1	80130808, 60143503 OR 80143510 BLK-L1, WHIT-L3 208V 3.5A 50/60HZ	PP10429 BLK-(2), WHIT-(5) 208	L1-38.9 A L2-38.9 A L3-38.9 A	50006609 17.0 KW 10 AWG	P5045701 40 A	L1-47.2 A L2-47.2 A L3-47.2 A	50006601 17.0 KW 10 AWG	P5045701 40 A
240 3 PHASE 3 WIRE & GND DELTA	1	1	80130804, 60143503 OR 80143510 BLK-L1, WHIT-L3 240V 3.5A 50/60HZ	PP10429 BLK-(1), WHIT-(5) 240	L1-33.7 A L2-33.7 A L3-33.7 A	50006612 14.0 KW 10 AWG	P5045701 40 A	L1-40.9 A L2-40.9 A L3-40.9 A	50006603 17.0 KW 10 AWG	P5045701 40 A
480 3 PHASE 3 WIRE & GND DELTA	3	3	80130801 OR 80143501 OR 80143510 BLK-L1, WHIT-L3 240V 3.5A 50/60HZ POWER CORO 1PH @ 120V 6.8A 50/60HZ	PP10428 BLK-(1), WHIT-(5) 480	L1-16.8 A L2-16.8 A L3-16.8 A	50006613 14.0 KW 14 AWG	P5045701 40 A	L1-20.4 A L2-20.4 A L3-20.4 A	50006604 17.0 KW 14 AWG	P5045701 40 A

**WIRE OPTION 3**  
480 VAC  
3 PHASE  
3 WIRE & GROUND  
(DELTA CONNECT)

ENTRANCE BOX

TO SHEET 1  
ESS3  
480V

WIR-14

MP1

FRAME

HEAT DEMAND

RIGHT SIDE

LEFT SIDE

**TABLE 2B LINE CONNECTION OPTIONS FOR U.S. AND CANADIAN SERVICES SE18X, SE18, SE18R**

LINE CONNECTIONS	VOLTAGE WIRES & GND LOAD TYPE	WIRE OPTION	FILTER PUMP P/N CONNECT VOLTAGE/AMPS	TRANSFORMER P/N CONNECT-(TAP) TAP VOLTS	MODEL SE18X			MODEL SE18R		
					TOTAL HEATER LESS OPTIONS NOTES 7/8	HTR1, HTR2 TOTAL HEAT KW 1A-3C WIRE SIZE	FUSES FS-F10 P/N AMPS	TOTAL HEATER LESS OPTIONS NOTES 7/8	HTR1, HTR2 TOTAL HEAT KW 1A-3C WIRE SIZE	FUSES FS-F10 P/N AMPS
208 3 PHASE 3 WIRE & GND DELTA	1	1	80130808, 60143503 OR 80143510 BLK-L1, WHIT-L3 208V 3.5A 50/60HZ	PP10429 BLK-(2), WHIT-(5) 208	L1-38.9 A L2-38.9 A L3-38.9 A	50006609 14.0 KW 10 AWG	P5045701 40 A	L1-47.2 A L2-47.2 A L3-47.2 A	50006601 17.0 KW 10 AWG	P5045701 40 A
240 3 PHASE 3 WIRE & GND DELTA	1	1	80130804, 60143503 OR 80143510 BLK-L1, WHIT-L3 240V 3.5A 50/60HZ	PP10429 BLK-(1), WHIT-(5) 240	L1-33.7 A L2-33.7 A L3-33.7 A	50006612 14.0 KW 10 AWG	P5045701 40 A	L1-40.9 A L2-40.9 A L3-40.9 A	50006603 17.0 KW 10 AWG	P5045701 40 A
480 3 PHASE 3 WIRE & GND DELTA	3	3	80130801 OR 80143501 OR 80143510 BLK-L1, WHIT-L3 240V 3.5A 50/60HZ POWER CORO 1PH @ 120V 6.8A 50/60HZ	PP10428 BLK-(1), WHIT-(5) 480	L1-16.8 A L2-16.8 A L3-16.8 A	50006613 14.0 KW 14 AWG	P5045701 40 A	L1-20.4 A L2-20.4 A L3-20.4 A	50006604 17.0 KW 14 AWG	P5045701 40 A

3 PHASE U.S. AND CANADIAN ELECTRICAL SERVICES  
FOR MODELS SE14X, SE14, SE14R, SE18X, SE18, SE18R

700329 Rev F



# Export and CE Wiring Diagrams (Filter Pump Option)

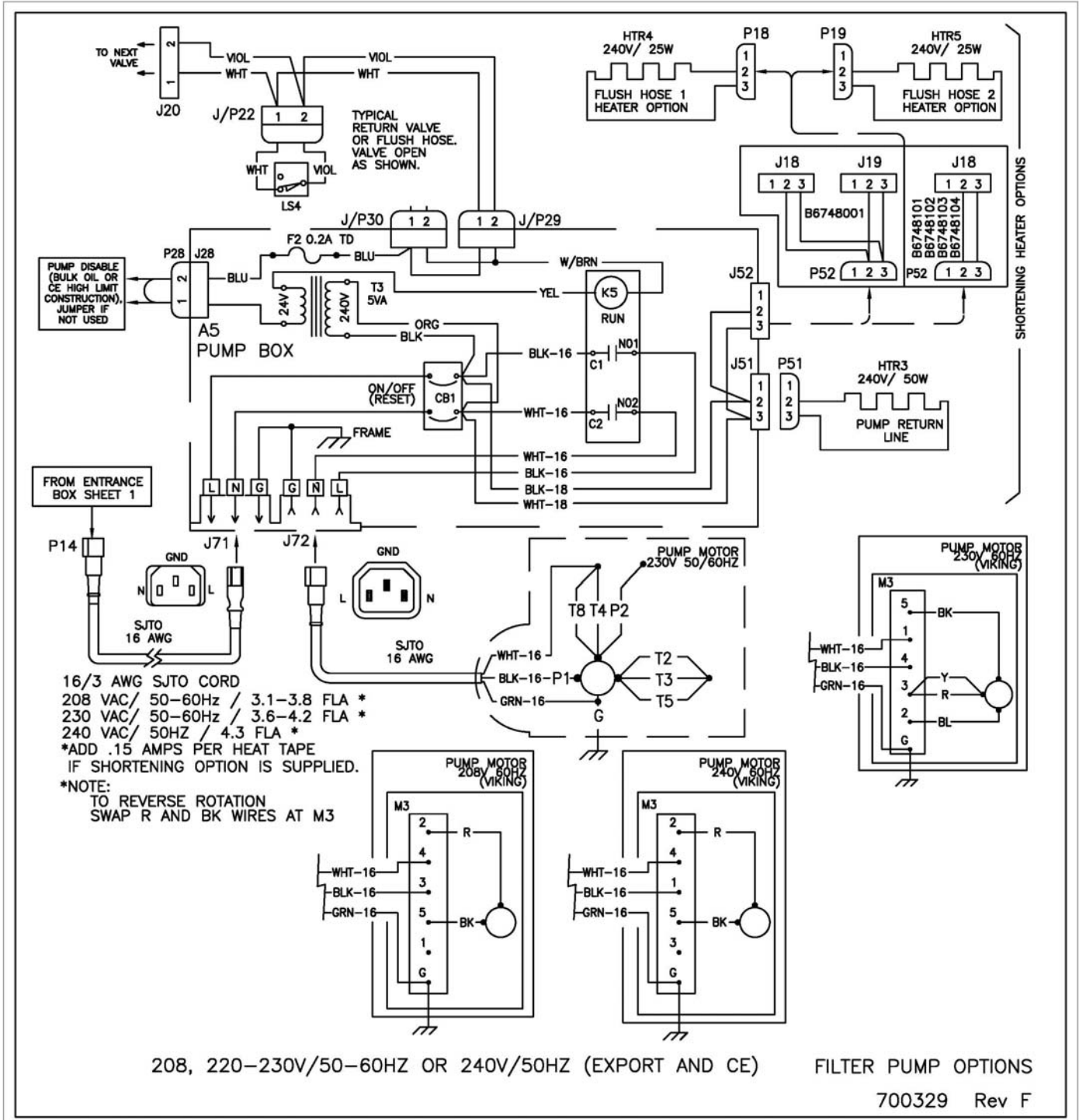

# Export and CE Wiring Diagrams (Single Phase Twin Vat)

**WIRE OPTION 16**  
 200VAC  
 230VAC  
 240VAC  
 1 PHASE  
 2 WIRE & GROUND

TO SHEET 1 BS3 200,220,230,240V

ENTRANCE BOX

LINE CONNECT

GROUND MP1 FRAME

TO HEATERS AS SHOWN AT LEFT

TO HEATERS AS SHOWN AT LEFT

HEAT DEMAND

HEAT DEMAND

**WIRE OPTION 17**  
 440 VAC  
 1 PHASE  
 2 WIRE & GROUND

TO SHEET 1 BS3 440V, NOTE 9.

ENTRANCE BOX

LINE CONNECT

GROUND MP1 FRAME

TO HEATERS AS SHOWN AT LEFT

TO HEATERS AS SHOWN AT LEFT

HEAT DEMAND

HEAT DEMAND

**TABLE 9 LINE CONNECTION OPTIONS FOR INTERNATIONAL SERVICES (SINGLE PHASE) SE147X, SE14T, SE14TR**

VOLTAGE PHASES	WIRE OPTION	WIRES & GND	FILTER PUMP P/N CONNECT	PUMP VOLTS/AMPS	TRANSFORMER P/N CONNECT-TAP TAP VOLTS	MODEL SE147X				MODEL SE14T				MODEL SE14TR			
						LINE AMPS	LEFT SIDE HTR 1 P/N	RIGHT SIDE HTR 2 P/N	TOTAL HEATER LESS OPTIONS NOTES 9,10	LINE AMPS	LEFT SIDE HTR 1 P/N	RIGHT SIDE HTR 2 P/N	TOTAL HEATER LESS OPTIONS NOTES 9,10	LINE AMPS	LEFT SIDE HTR 1 P/N	RIGHT SIDE HTR 2 P/N	TOTAL HEATER LESS OPTIONS NOTES 9,10
200	1	1 PHASE	60130808 OR 60143503	208V 3.8A 50/60Hz	L1-(2) N-(5) 208	50006609	50006609	50006601	50006601	50006605	50006605	50006605	50006605	50006605	50006605	50006605	50006605
230	1	1 PHASE	60130801 OR 60143501	230V 3.4A 50/60Hz	L1-(2) N-(5) 240	50006610	50006610	50006602	50006602	50006606	50006606	50006606	50006606	50006606	50006606	50006606	50006606
240	1	1 PHASE	60130801 OR 60143501	240V 3.5A 50/60Hz	L1-(2) N-(5) 240	50006611	50006611	50006614	50006614	50006615	50006615	50006615	50006615	50006615	50006615	50006615	50006615
440	1	1 PHASE	60130801 OR 60143501	230V 3.4A 50/60Hz	L1-(2) N-(5) 440	50006613	50006613	50006604	50006604	50006608	50006608	50006608	50006608	50006608	50006608	50006608	50006608

SINGLE PHASE INTERNATIONAL SERVICES SE147X, SE14T, SE14TR  
 700329 Rev F

# Export and CE Wiring Diagrams (Single Phase Full Vat)

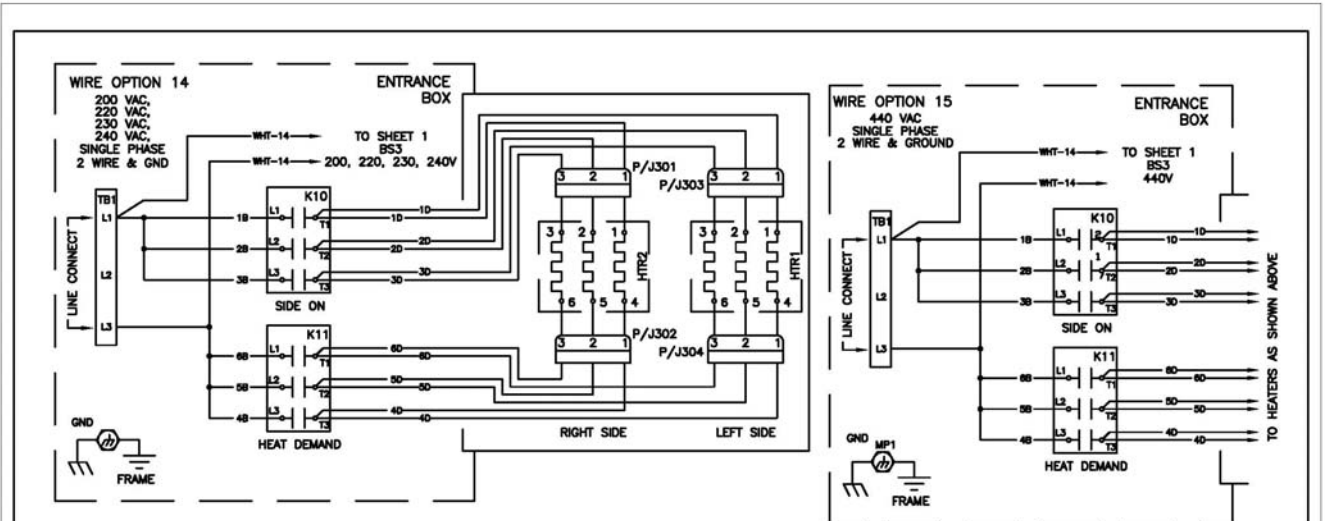

**TABLE 6 LINE CONNECTION OPTIONS FOR INTERNATIONAL SERVICES (SINGLE PHASE) SE14X, SE14, SE14R**

LINE CONNECTIONS		FILTER PUMP	TRANSFORMER	MODEL SE14X		MODEL SE14		MODEL SE14R	
VOLTAGE PHASES	WIRE OPTION	P/N CONNECT	P/N CONNECT-(TAP)	LINE AMPS NOTES 9,10	HTR1, HTR2 P/N TOTAL HEAT KW 1A-3C WIRE SIZE	LINE AMPS NOTES 9,10	HTR1, HTR2 P/N TOTAL HEAT KW 1A-3C WIRE SIZE	LINE AMPS NOTES 9,10	HTR1, HTR2 P/N TOTAL HEAT KW 1A-3C WIRE SIZE
200 1 PHASE 2 WIRE & GND	14	60130808 OR 60143503 BLK-L1, WHT-L3 208V 3.8A 50/60Hz	PP10429 L1-(2) N-(5) 208	L-64.7 A	50006609 12.9 KW 10 AWG	L-78.6 A	50006601 15.7 KW 10 AWG	L-102 A	50006605 21.3 KW 10 AWG
220 1 PHASE 2 WIRE & GND	14	60130801 OR 60143501 BLK-L1, WHT-L3 230V 3.4A 50/60Hz	PP10429 L1-(1) N-(5) 240	L-63.6 A	50006610 14.0 KW 10 AWG	L-77.3 A	50006602 17.0 KW 10 AWG	L-100 A	50006606 22.0 KW 10 AWG
230 1 PHASE 2 WIRE & GND	14	60130801, 60143501 OR 60143511 BLK-L1, WHT-L3 230V 3.4A 50/60Hz	PP10429 L1-(1) N-(5) 240	L-60.9 A	50006611 14.0 KW 10 AWG	L-73.9 A	50006614 17.0 KW 10 AWG	L-95.7 A	50006615 22.0 KW 10 AWG
240 1 PHASE 2 WIRE & GND	14	60130804, 60143503 OR 60143510 BLK-L1, WHT-L3 240V 3.5A 50/60Hz	PP10429 L1-(1) N-(5) 240	L-58.3 A	50006612 14.0 KW 14 AWG	L-70.8 A	50006603 17.0 KW 14 AWG	L-91.7 A	50006607 22.0 KW 14 AWG
440 1 PHASE 2 WIRE & GND	15	60130801 OR 60143501 WITH SEPARATE POWER CORD 1PH @ 230V 3.4A 50/60Hz	PP10428 L1-(2) N-(5) 440	L-26.7 A	50006613 11.8 KW 14 AWG	L-32.5 A	50006604 14.3 KW 14 AWG	L-42.0 A	50006608 18.5 KW 14 AWG

**TABLE 6A LINE CONNECTION OPTIONS FOR INTERNATIONAL SERVICES (SINGLE PHASE) SE18X, SE18, SE18R**

LINE CONNECTIONS		FILTER PUMP	TRANSFORMER	MODEL SE18X		MODEL SE18		MODEL SE18R	
VOLTAGE PHASES	WIRE OPTION	P/N CONNECT	P/N CONNECT-(TAP)	LINE AMPS NOTES 9,10	HTR1, HTR2 P/N TOTAL HEAT KW 1A-3C WIRE SIZE	LINE AMPS NOTES 9,10	HTR1, HTR2 P/N TOTAL HEAT KW 1A-3C WIRE SIZE	LINE AMPS NOTES 9,10	HTR1, HTR2 P/N TOTAL HEAT KW 1A-3C WIRE SIZE
200 1 PHASE 2 WIRE & GND	14	60130808 OR 60143503 BLK-L1, WHT-L3 208V 3.8A 50/60Hz	PP10429 L1-(2) N-(5) 208	L-64.7 A	50006609 12.9 KW 10 AWG	L-78.6 A	50006601 15.7 KW 10 AWG	L-102 A	50006605 20.3 KW 10 AWG
220 1 PHASE 2 WIRE & GND	14	60130801 OR 60143501 BLK-L1, WHT-L3 230V 3.4A 50/60Hz	PP10429 L1-(1) N-(5) 240	L-63.6 A	50006610 14.0 KW 10 AWG	L-77.3 A	50006602 17.0 KW 10 AWG	L-100 A	50006606 22.0 KW 10 AWG
230 1 PHASE 2 WIRE & GND	14	60130801 OR 60143501 OR 60143511 BLK-L1, WHT-L3 230V 3.4A 50/60Hz	PP10429 L1-(1) N-(5) 240	L-60.9 A	50006611 14.0 KW 10 AWG	L-73.9 A	50006614 17.0 KW 10 AWG	L-95.7 A	50006615 22.0 KW 10 AWG
240 1 PHASE 2 WIRE & GND	14	60130804 OR 60143503 OR 60143510 BLK-L1, WHT-L3 240V 3.5A 50/60Hz	PP10429 L1-(1) N-(5) 240	L-58.3 A	50006612 14.0 KW 14 AWG	L-70.8 A	50006603 17.0 KW 14 AWG	L-91.7 A	50006607 22.0 KW 14 AWG
440 1 PHASE 2 WIRE & GND	15	60130801 OR 60143501 WITH SEPARATE POWER CORD 1PH @ 230V 3.4A 50/60Hz	PP10428 L1-(2) N-(5) 440	L-26.7 A	50006613 11.8 KW 14 AWG	L-32.5 A	50006604 14.3 KW 14 AWG	L-42.0 A	50006608 18.5 KW 14 AWG

FOR SINGLE PHASE MODELS SE14X, SE14, SE14R, SE18X, SE18, SE18R

700329 Rev F

# Export and CE Wiring Diagrams (3 Phase Full Vat)

**WIRE OPTION 4**  
200 VAC, 200/220 VAC, 230 VAC, 240 VAC, 3 PHASE, 3 WIRE & GROUND (DELTA CONNECT)

**WIRE OPTION 5**  
380V/220 VAC, 400V/230 VAC, 415V/240 VAC, 3 PHASE, 4 WIRE & GND (Y CONNECT)

**WIRE OPTION 6**  
140 VAC, 3 PHASE, 3 WIRE & GROUND (DELTA CONNECT)

**TABLE 3A. LINE CONNECTION OPTIONS FOR INTERNATIONAL SERVICES SE14X, SE14, SE14R**

LINE CONNECTIONS	FILTER PUMP	TRANSFORMER	MODEL SET4X		MODEL SET4R	
			F/N CONNECT-TAP	TAP VOLTS	F/N CONNECT-TAP	TAP VOLTS
230 VOLTAGE 3 PHASE 3 WIRE & GND DELTA	60130801 OR 60143501 OR 60143511 BLK-L1, WHT-L3 230V 3.4A 50/60HZ	P/10429 L1-(1) L2-(5) 240	L1-37.4 A L2-37.4 A L3-37.4 A	50006609 10 AWG	L1-45.4 A L2-45.4 A L3-45.4 A	50006601 10 AWG
240 VOLTAGE 3 PHASE 3 WIRE & GND DELTA	60130801 OR 60143501 OR 60143511 BLK-L1, WHT-L3 230V 3.4A 50/60HZ	P/10429 L1-(1) L2-(5) 240	L1-36.7 A L2-36.7 A L3-36.7 A	50006610 10 AWG	L1-44.8 A L2-44.8 A L3-44.8 A	50006602 10 AWG
230 VOLTAGE 3 PHASE 3 WIRE & GND DELTA	60130801, 60143501 OR 60143511 BLK-L1, WHT-L3 230V 3.4A 50/60HZ	P/10429 L1-(1) L2-(5) 240	L1-35.1 A L2-35.1 A L3-35.1 A	50006611 10 AWG	L1-42.7 A L2-42.7 A L3-42.7 A	50006614 10 AWG
240 VOLTAGE 3 PHASE 3 WIRE & GND DELTA	60130801, 60143501 OR 60143511 BLK-L1, WHT-L3 230V 3.4A 50/60HZ	P/10429 L1-(1) L2-(5) 240	L1-33.7 A L2-33.7 A L3-33.7 A	50006612 10 AWG	L1-40.9 A L2-40.9 A L3-40.9 A	50006603 10 AWG
3467/200 VOLTAGE 3 PHASE 4 WIRE & GND	60130808 OR 60143503 BLK-L1, WHT-N 208V 3.6A 50/60HZ	P/10429 L1-(2) N-(6) 208	L1-21.6 A L2-21.6 A L3-21.6 A	50006609 10 AWG	L1-26.2 A L2-26.2 A L3-26.2 A	50006601 10 AWG
380V/220 VOLTAGE 3 PHASE 4 WIRE & GND WYE	60130801 OR 60143501 BLK-L1, WHT-N 230V 3.4A 50/60HZ	P/10429 L1-(1) N-(6) 240	L1-21.3 A L2-21.3 A L3-21.3 A	50006610 10 AWG	L1-25.8 A L2-25.8 A L3-25.8 A	50006602 10 AWG
400V/230 VOLTAGE 3 PHASE 4 WIRE & GND WYE	60130801, 60143501 OR 60143511 BLK-L1, WHT-N 230V 3.4A 50/60HZ	P/10429 L1-(1) L2-(6) 240	L1-20.2 A L2-20.2 A L3-20.2 A	50006611 10 AWG	L1-24.5 A L2-24.5 A L3-24.5 A	50006614 10 AWG
415V/240 VOLTAGE 3 PHASE 4 WIRE & GND WYE	60130804, 60143503 OR 60143510 BLK-L1, WHT-N 240V 3.5A 50/60HZ	P/10429 L1-(1) N-(6) 240	L1-19.5 A L2-19.5 A L3-19.5 A	50006612 10 AWG	L1-23.7 A L2-23.7 A L3-23.7 A	50006603 10 AWG
440 VOLTAGE 3 PHASE 3 WIRE & GND DELTA	60130801 OR 60143501 WITH SEPARATE POWER CORD 1PH @ 230V 3.4A 50/60HZ	P/10429 L1-(2) L3-(5) 440	L1-15.4 A L2-15.4 A L3-15.4 A	50006613 14 AWG	L1-18.7 A L2-18.7 A L3-18.7 A	50006604 14 AWG

3 PHASE INTERNATIONAL ELECTRICAL SERVICES  
FOR MODELS SE14X, SE14, SE14R

700329 Rev F

# Export and CE Wiring Diagrams (3 Phase Twin WYE Vat)

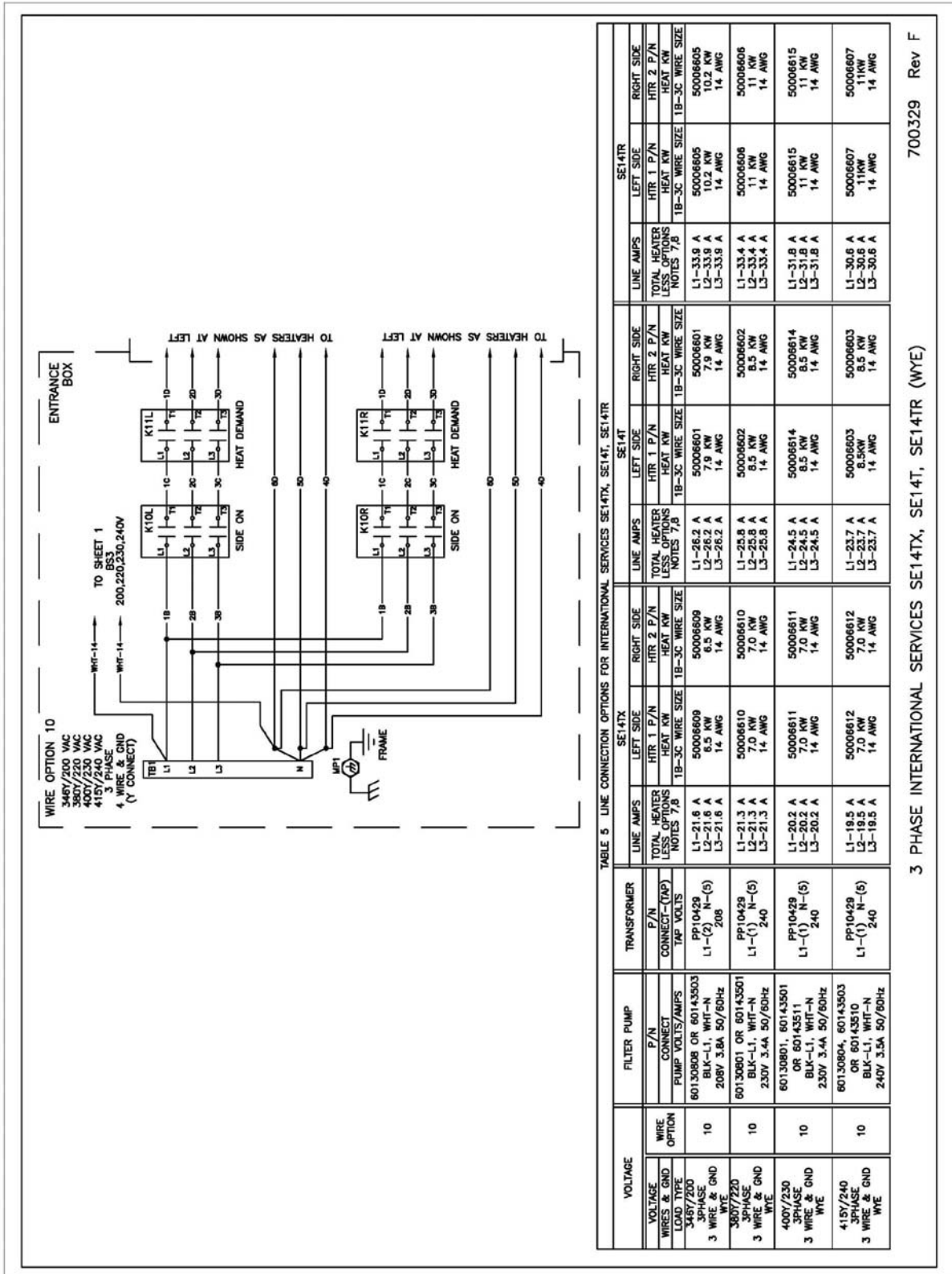

TABLE 5 LINE CONNECTION OPTIONS FOR INTERNATIONAL SERVICES SE14TX, SE14T, SE14TR

VOLTAGE WIRE & GND LOAD TYPE	WIRE OPTION	FILTER PUMP P/N CONNECT PUMP VOLTS/AMPS	TRANSFORMER P/N CONNECT-(TAP) TAP VOLTS	SE14TX			SE14T			SE14TR		
				LINE AMPS TOTAL HEATER LESS OPTIONS NOTES 7/B	RIGHT SIDE HTR 1 P/N HEAT KW 1B-3C WIRE SIZE	LEFT SIDE HTR 1 P/N HEAT KW 1B-3C WIRE SIZE	LINE AMPS TOTAL HEATER LESS OPTIONS NOTES 7/B	RIGHT SIDE HTR 2 P/N HEAT KW 1B-3C WIRE SIZE	LEFT SIDE HTR 2 P/N HEAT KW 1B-3C WIRE SIZE	LINE AMPS TOTAL HEATER LESS OPTIONS NOTES 7/B	RIGHT SIDE HTR 2 P/N HEAT KW 1B-3C WIRE SIZE	LEFT SIDE HTR 2 P/N HEAT KW 1B-3C WIRE SIZE
348V/200 3-PHASE & GND	10	60130808 OR 60143503 BLX-L1, WHT-N 208V 3.8A 50/60Hz	PP10429 L1-(2) N-(5) 208	L1-21.6 A L2-21.6 A L3-21.6 A 6.5 KW 14 AWG	50006609 6.5 KW 14 AWG	50006601 7.9 KW 14 AWG	50006601 7.9 KW 14 AWG	L1-26.2 A L2-26.2 A L3-26.2 A 7.9 KW 14 AWG	50006601 7.9 KW 14 AWG	50006605 10.2 KW 14 AWG	L1-33.9 A L2-33.9 A L3-33.9 A 10.2 KW 14 AWG	50006605 10.2 KW 14 AWG
396V/220 3-PHASE & GND	10	60130801 OR 60143501 BLX-L1, WHT-N 230V 3.4A 50/60Hz	PP10429 L1-(1) N-(5) 240	L1-21.3 A L2-21.3 A L3-21.3 A 7.0 KW 14 AWG	50006610 7.0 KW 14 AWG	50006602 8.5 KW 14 AWG	50006602 8.5 KW 14 AWG	L1-25.8 A L2-25.8 A L3-25.8 A 8.5 KW 14 AWG	50006602 8.5 KW 14 AWG	50006606 11 KW 14 AWG	L1-33.4 A L2-33.4 A L3-33.4 A 11 KW 14 AWG	50006606 11 KW 14 AWG
400V/230 3-PHASE & GND	10	60130801, 60143501 OR 60143511 BLX-L1, WHT-N 230V 3.4A 50/60Hz	PP10429 L1-(1) N-(5) 240	L1-20.2 A L2-20.2 A L3-20.2 A 7.0 KW 14 AWG	50006611 7.0 KW 14 AWG	50006614 8.5 KW 14 AWG	50006614 8.5 KW 14 AWG	L1-24.5 A L2-24.5 A L3-24.5 A 8.5 KW 14 AWG	50006614 8.5 KW 14 AWG	50006615 11 KW 14 AWG	L1-31.8 A L2-31.8 A L3-31.8 A 11 KW 14 AWG	50006615 11 KW 14 AWG
415V/240 3-PHASE & GND	10	60130804, 60143503 OR 60143510 BLX-L1, WHT-N 240V 3.5A 50/60Hz	PP10429 L1-(1) N-(5) 240	L1-19.5 A L2-19.5 A L3-19.5 A 7.0 KW 14 AWG	50006612 7.0 KW 14 AWG	50006603 8.5 KW 14 AWG	50006603 8.5 KW 14 AWG	L1-23.7 A L2-23.7 A L3-23.7 A 8.5 KW 14 AWG	50006603 8.5 KW 14 AWG	50006607 11KW 14 AWG	L1-30.6 A L2-30.6 A L3-30.6 A 11KW 14 AWG	50006607 11KW 14 AWG

3 PHASE INTERNATIONAL SERVICES SE14TX, SE14T, SE14TR (WYE)

700329 Rev F

# Export and CE Wiring Diagrams (3 Phase Twin Delta Vat)

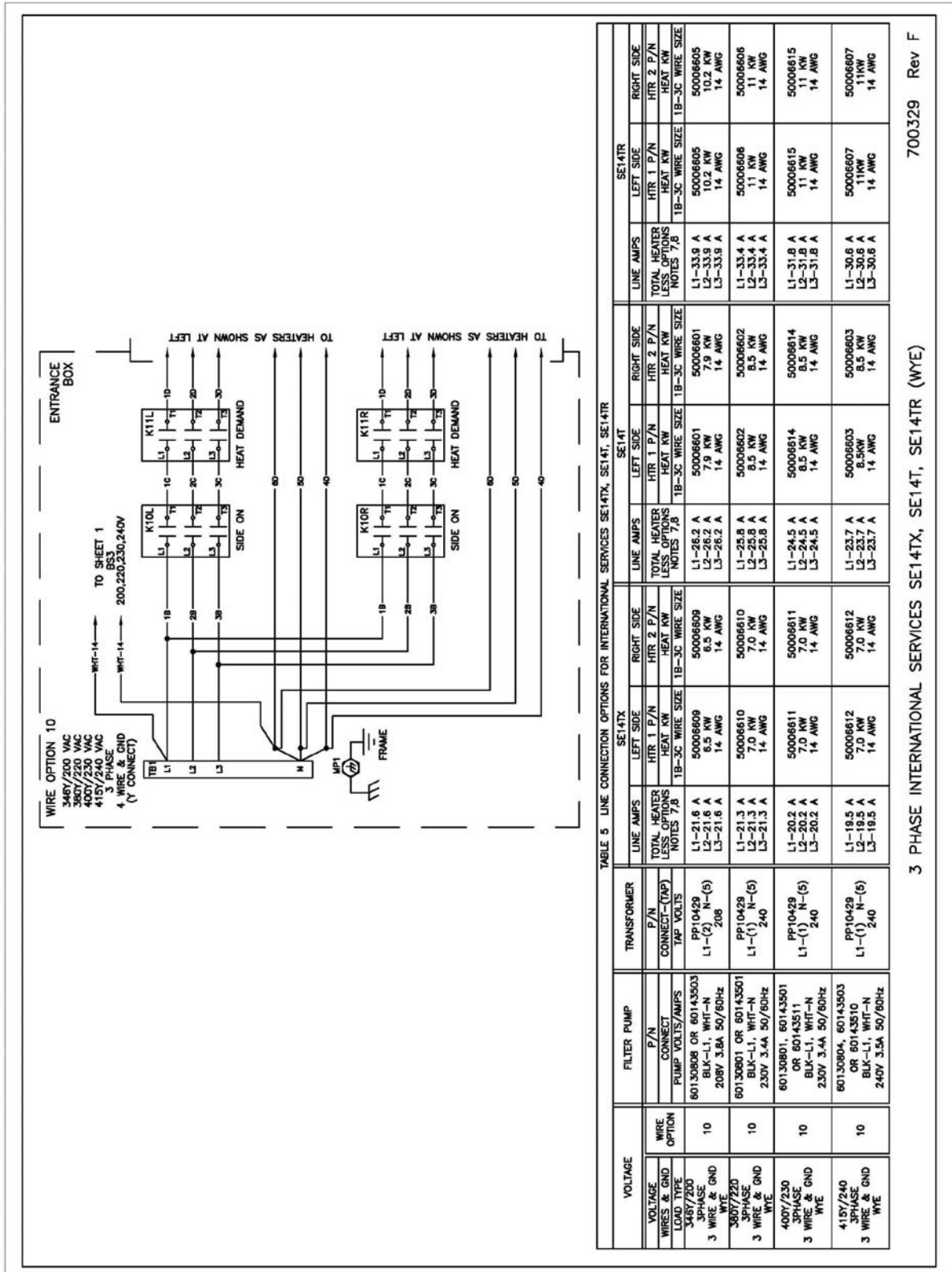

TABLE 5 LINE CONNECTION OPTIONS FOR INTERNATIONAL SERVICES SE14TX, SE14T, SE14TR

VOLTAGE	WIRE OPTION	FILTER PUMP	TRANSFORMER	SE14TX			SE14T			SE14TR		
				LINE AMPS	LEFT SIDE	RIGHT SIDE	LINE AMPS	LEFT SIDE	RIGHT SIDE	LINE AMPS	LEFT SIDE	RIGHT SIDE
400Y/230 3PHASE WYE	10	601.30808 OR 601.43503 BLK-L1, WHT-N 208V 3.5A 50/60HZ	PP10429 L1-(2) N-(5) 208	L1-21.6 A L2-21.6 A L3-21.6 A	L1-26.2 A L2-26.2 A L3-26.2 A	L1-26.2 A L2-26.2 A L3-26.2 A	L1-33.8 A L2-33.8 A L3-33.8 A	L1-33.8 A L2-33.8 A L3-33.8 A	L1-33.8 A L2-33.8 A L3-33.8 A	L1-33.8 A L2-33.8 A L3-33.8 A	L1-33.8 A L2-33.8 A L3-33.8 A	L1-33.8 A L2-33.8 A L3-33.8 A
380Y/220 3PHASE WYE	10	601.30801 OR 601.43501 BLK-L1, WHT-N 230V 3.4A 50/60HZ	PP10429 L1-(1) N-(5) 240	L1-21.3 A L2-21.3 A L3-21.3 A	L1-25.8 A L2-25.8 A L3-25.8 A	L1-25.8 A L2-25.8 A L3-25.8 A	L1-33.4 A L2-33.4 A L3-33.4 A	L1-33.4 A L2-33.4 A L3-33.4 A	L1-33.4 A L2-33.4 A L3-33.4 A	L1-33.4 A L2-33.4 A L3-33.4 A	L1-33.4 A L2-33.4 A L3-33.4 A	L1-33.4 A L2-33.4 A L3-33.4 A
400Y/230 3PHASE WYE	10	601.30804, 601.43501 OR 601.43511 BLK-L1, WHT-N 230V 3.4A 50/60HZ	PP10429 L1-(1) N-(5) 240	L1-20.2 A L2-20.2 A L3-20.2 A	L1-24.5 A L2-24.5 A L3-24.5 A	L1-24.5 A L2-24.5 A L3-24.5 A	L1-31.8 A L2-31.8 A L3-31.8 A	L1-31.8 A L2-31.8 A L3-31.8 A	L1-31.8 A L2-31.8 A L3-31.8 A	L1-31.8 A L2-31.8 A L3-31.8 A	L1-31.8 A L2-31.8 A L3-31.8 A	L1-31.8 A L2-31.8 A L3-31.8 A
415Y/240 3PHASE WYE	10	601.30804, 601.43503 OR 601.43510 BLK-L1, WHT-N 240V 3.5A 50/60HZ	PP10429 L1-(1) N-(5) 240	L1-19.5 A L2-19.5 A L3-19.5 A	L1-23.7 A L2-23.7 A L3-23.7 A	L1-23.7 A L2-23.7 A L3-23.7 A	L1-30.8 A L2-30.8 A L3-30.8 A	L1-30.8 A L2-30.8 A L3-30.8 A	L1-30.8 A L2-30.8 A L3-30.8 A	L1-30.8 A L2-30.8 A L3-30.8 A	L1-30.8 A L2-30.8 A L3-30.8 A	L1-30.8 A L2-30.8 A L3-30.8 A

3 PHASE INTERNATIONAL SERVICES SE14TX, SE14T, SE14TR (WYE) 700329 Rev F

# Notes

---

In the event of problems with or questions about your order, please contact Pitco Frialator factory at: 603-225-6684 World Wide  
[www.pitco.com](http://www.pitco.com)

In the event of problems with questions about your order, please contact Pitco Frialator Authorized Service and Parts representative (ASAP) covering your area or contact Pitco at the number listed to the left.

MAILING ADDRESS – P.O. BOX 501 CONCORD, NH 03302-0501  
SHIPPING ADDRESS – 10 FERRY STREET, CONCORD, NH 03301